

RONDADDESIGN.IT

RONDADDESIGN.IT

B E A T T R A C T I V E

rondadesign >

rondadesign >



**Ronda Design**  
**sfida il pensiero convenzionale**  
**ridisegnando le regole dell'arredo**

Ronda design challenges  
conventional thinking  
by redesigning the rules of furnishing

” Il prodotto Ronda Design è l’espressione dei valori che contraddistinguono l’azienda: passione, innovazione, know-how ”

G.C. art director

Ronda Design’s products are built on the company’s distinguishing values: passion, innovation and know-how.

**Passione e creatività**, uniti alla profonda esperienza tecnica dei propri fondatori, fanno di **Ronda Design** un incubatore eccezionale di idee innovative e soluzioni tecniche uniche e all’avanguardia. Il sistema di arredo magnetico è senza dubbio la creazione più distintiva dell’azienda, un progetto in continua evoluzione che trova applicazione sia nell’ambiente domestico che in quello commerciale e lavorativo. La flessibilità e la dinamicità delle pareti magnetiche permette di superare i limiti delle comuni soluzioni d’arredo e apre la strada alla creatività di ogni singolo utilizzatore. Le pareti magnetiche rendono unico e funzionale ogni ambiente della casa, dalla cucina al soggiorno, dalla camera da letto alla cabina armadio, dall’ingresso al bagno. La profonda conoscenza dei metalli, guadagnata con mezzo secolo di attività nella produzione di arredo in acciaio inossidabile, si manifesta altresì nella vasta gamma di complementi d’arredo per la zona living. Librerie, tavoli e sedie, lampade e altri piccoli complementi che per design e finiture permettono di realizzare insieme alle pareti magnetiche un ambiente unico e coordinato.

**Passion and creativity**, combined with the technical experience of its founders, make **Ronda Design** excel as a company and have led to exceptional innovative ideas and unique cutting-edge technical solutions. Its magnetic wall system is undoubtedly the most distinctive creation from the company and is constantly evolving to produce even better products that work in both the home and commercial spaces. The flexibility of the magnetic walls allows customers to overcome common restrictions of other furniture products and allows the customer to become the designer and create a wall that is perfect and unique to them. They make every room truly unique and functional, from the kitchen to the living room, the bedroom to the walk-in wardrobe, hallway to the bathroom. The team also has a wealth of experience in the metal industry and therefore in addition, **Ronda Design** also creates numerous furnishings that complement its magnetic wall system, including bookcases, tables and chairs, lamps as well as other small accessories.

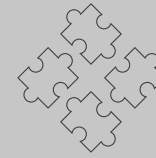

**Componibilità illimitata per la massima flessibilità.**

I prodotti Ronda Design sono stati studiati per essere combinabili tra di loro in modo semplice e dinamico. Pareti magnetiche e complementi seguono una stessa linea di pensiero e permettono quindi di realizzare interni dal design originale ed elegante. Il sistema magnetico ha la flessibilità nel proprio DNA e permette di creare soluzioni personalizzate che rispondono alle esigenze di ogni singolo individuo. E se domani le esigenze dovessero cambiare... basta un tocco per riorganizzare la parete in modo totalmente nuovo e originale.

**Unlimited modularity for maximum flexibility.**

Ronda Design’s products have been designed to work alongside each other in a simple and dynamic way. Magnetic walls and accessories follow the same line of thought: to create original and stylish interiors. Flexibility is in the DNA of the magnetic system, which allows customers to easily move accessories and completely customize the wall to suit their individual needs. What if tomorrow you decide you want a new look, then you can simply rearrange the wall to create a new perfect layout.

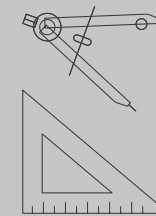

**Soluzioni su misura per ogni esigenza.**

Ronda Design è sempre al fianco dell’arredatore per soddisfare ogni sua esigenza. Il sistema magnetico e la vasta gamma di misure e finiture a catalogo permettono di realizzare un numero illimitato di soluzioni, e, se le specifiche esigenze di arredo lo richiedessero, il team di Ronda Design è sempre pronto a realizzare prodotti personalizzati per disegno, dimensioni e finiture.

**Tailor-made solutions for every need.**

Ronda Design have a dedicated team of in-house interior designers, ready to satisfy your every need. The magnetic wall system comes in a wide range of standard sizes and finishes, but if an alternative is needed, their interior designers can help create bespoke designs, made to the customers specifications.

magnetika®

**Sistema magnetico brevettato.**

Ronda Design nasce dall’idea che il mondo dell’arredo ha bisogno di soluzioni flessibili e dinamiche che si adattino alle esigenze in continua evoluzione di ogni utilizzatore. Anni di studio e ricerca applicata hanno portato l’azienda a sviluppare numerose soluzioni progettuali basate sul magnetismo. Magnetika è oggi un marchio registrato ed è l’espressione di una vasta gamma di soluzioni basate sul sistema magnetico brevettato dall’azienda.

**Patented magnetic system.**

Ronda Design was created with the idea that the furniture world needs flexible and dynamic solutions that adapt to the ever-changing needs of each user. Years of study and applied research have led the company to develop numerous design solutions based on magnetism. Magnetika is a registered trademark and is the name given to their collection of magnetic wall system products, a system that is patented by Ronda Design.

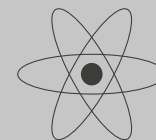

**Passione per la sperimentazione.**

Ogni giorno il team di sviluppo di Ronda Design sprigiona la propria creatività per mantenere la propria unicità e distinguersi nel mondo dell’arredo. Senza sosta elabora nuove idee, studia e sperimenta nuove soluzioni tecniche per rendere l’arredo sempre più funzionale e innovativo. Passione e creatività sono l’anima e la forza di Ronda Design.

**Passion for experimentation.**

Every day the Ronda Design development team is working to create fresh innovative ideas to maintain its uniqueness and stand out in the world of furniture. They are constantly developing new ideas, studying, and experimenting with new technical solutions to make their products even better. Passion and creativity are the soul and strength of Ronda Design.



# Indice dei contenuti / Content index

Ambientazioni sistema magnetico \_ Magnetic system settings



**Zona giorno** pag. 8 - 39  
Living room



**Sala da pranzo** pag. 40 - 57  
Dining room



**Wine bar** pag. 58 - 61



**Cucina** pag. 62 - 75  
Kitchen



**Ingresso** pag. 76 - 89  
Entrance



**Camera da letto** pag. 90 - 99  
Bedroom



**Cabina armadio** pag. 100 - 103  
Walk-in closet



**Bagno** pag. 104 - 109  
Bathroom

Complementi d'arredo \_ Furnishings



**Tavoli e sedie** pag. 122 - 181  
Tables and chairs



**Madie e librerie** pag. 182 - 227  
Sideboards and bookcases



**Complementi** pag. 228 - 243  
Furnishing accessories



**Lampade** pag. 244 - 263  
Lamps



# Sistema magnetico

MAGNETIKA È UN NUOVO MODO DI ARREDARE, UNA SOLUZIONE SEMPLICE ED INTELLIGENTE PER RISPONDERE AD ESIGENZE E GUSTI DI UN PUBBLICO IN CONTINUA EVOLUZIONE. IL SISTEMA MAGNETICO PERMETTE DI ARREDARE UNA PARETE SFRUTTANDO QUATTRO TEMI MOLTO CARI AL PROGETTISTA: UNA VASTA GAMMA DI MATERIALI E FINITURE PER ARRICCHIRE L'AMBIENTE, ACCESSORI MAGNETICI FUNZIONALI E DIVERTENTI PER DARE UNICITÀ E DINAMICITÀ ALLA COMPOSIZIONE, ELEMENTI CONTENITIVI PER CUSTODIRE GLI OGGETTI PIÙ CARI ED INFINE SOLUZIONI LUMINOSE PER CREARE LA GIUSTA ATMOSFERA.

MAGNETIKA IS A NEW WAY OF FURNISHING, A SIMPLE AND SMART SOLUTION TO MEET THE NEEDS AND TASTES OF A CONSTANTLY EVOLVING WORLD. THE MAGNETIC SYSTEM ALLOWS THE INTERIOR DESIGNER TO FURNISH A WALL USING FOUR BASIC PRINCIPLES: A WIDE RANGE OF MATERIALS AND FINISHES TO ENRICH THE ENVIRONMENT, A VARIED CHOICE OF FUNCTIONAL AND FUN MAGNETIC ACCESSORIES TO CREATE A UNIQUE AND DYNAMIC COMPOSITION, STORAGE SOLUTIONS AND A SERIES OF ILLUMINATED ACCESSORIES TO CREATE THE RIGHT ATMOSPHERE.

## Magnetic system



**Pannelli \_ Panels**

La parete del sistema magnetico è un elemento fondamentale della composizione, sia dal punto di vista funzionale che estetico. Il metallo è il materiale di riferimento e si presenta in una vasta gamma di finiture, dal ferro naturale alle finiture brunate. La boiserie può inoltre essere rivestita con un sottile strato di materiale diverso, pur mantenendo la propria capacità di attrarre le mensole magnetiche: dal legno al vetro, dalla ceramica effetto marmo allo specchio, ogni stile trova la sua parete magnetica ideale!

The wall paneling is the fundamental element of the magnetic composition, both functionally and aesthetically. The panels are made from metal and come in a wide range of finishes, from natural iron to burnished finishes. The panels can also be covered with a thin layer of different materials, while maintaining their ability to attract magnetic shelves: from wood to glass, from marble-effect ceramics to mirrors, every style finds its ideal magnetic wall!



**Accessori \_ Accessories**

Gli accessori magnetici sono la vera essenza di Magnetika, lo strumento principale che permette ad ognuno di liberare la propria creatività realizzando composizioni che rispondano perfettamente alle proprie esigenze e preferenze. Non solo mensole, ma portabottiglie, specchi, appendiabiti, lampade e accessori vari, con una portata parametrata alla dimensione di appoggio per sostenere in tutta sicurezza anche gli oggetti più preziosi. Il sistema magnetico Ronda Design è studiato per avere un'elevata tenuta, una durata permanente ed una schermatura delle onde magnetiche per evitare ogni interferenza con apparecchi sensibili al magnetismo.

The magnetic accessories are the true essence of Magnetika, the elements that allow customers to be the designer and create compositions that perfectly meet their needs and preferences. In addition to shelves there is a selection of bottle holders, mirrors, coat hangers, lamps and various accessories, with a load capacity parameterized to the size of the accessory, to safely support even the most precious objects. Ronda Design's magnetic system is designed to have a high capacity, permanent duration and shielding of magnetic waves to avoid any interference with devices sensitive to magnetism.



**Contenitori \_ Cabinets**

La nuova collezione di elementi pensili, perfettamente integrabile alla composizione di pannelli del sistema magnetico, rende ancora più funzionale la parete. Contenitori a giorno, vetrinette e madie componibili e sospese si affiancano quindi alla collezione di accessori magnetici, rispondendo alla duplice esigenza di sostenere elevati carichi e di fare ordine e facilitare la pulizia.

The new collection of wall units, which can be perfectly integrated into the wall paneling composition, makes walls even more functional. Open storage units, display cabinets, modular and suspended sideboards complement the collection of magnetic accessories, responding to the dual need to support heavier items and offer effective storage.



**Illuminazione \_ Lighting**

Non si può parlare di arredo senza pensare all'atmosfera che solo un sistema ben pensato di illuminazione può generare. La luce diventa quindi un elemento fondamentale per progettare la parete magnetica. Che si tratti di un fascio di luce integrato ai pannelli oppure di una lampada magnetica liberamente posizionabile sulla boiserie, la luce contribuisce a creare un ambiente unico e accogliente, funzionale e decorativo. La tecnologia led comune a tutti gli elementi luminosi Ronda Design, permette di contenere i consumi e facilitarne la manutenzione.

We cannot talk about furnishing without thinking about the feel that only a well thought out lighting system can create. Lighting becomes a fundamental element to create a finely finished look. Whether it is a beam of light integrated into the panels, or a magnetic lamp that can be freely positioned onto the wall paneling, the light helps to create a unique and welcoming, functional and decorative environment. The led technology, common to all Ronda Design's lighting products, is energy efficient and maintenance free.







**Flat** design: Ronda Design Lab

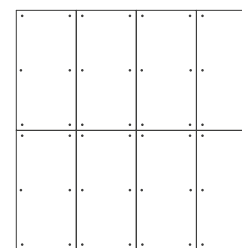

Composition 01  
L 3200 H 3200 P 1,5 mm

Boiserie composta da fogli di lamiera in ferro naturale. Mensole magnetiche e lampade led magnetiche in finitura tortora. Dettagli in basso in finitura nero.

Wall cladding composed of flat metal sheets, natural iron finish. Magnetic shelving and led lamps in taupe finish. Pictures below in black finish.

 **Cart**  
Mensola magnetica. Magnetic shelf.

 **Brand**  
Lampada magnetica ricaricabile. Rechargeable magnetic lamp.











**Caddy** design: Gino Carollo

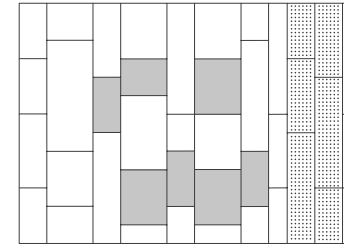

Composition 02  
L 3700 H 2600 P 400 mm

Boiserie composta da pannelli in metallo verniciato ed elementi impiallacciati rovere smoked. Madia componibile e pensili in metallo integrati alla composizione. Vetrinette pensili con anta in vetro fumé e strip led interni. Mensole magnetiche. Finitura grafite.

Wall metal paneling including smoked oak veneered panels. Modular suspended sideboard and cabinets. Glass cabinets with smoked glass door and internal led lighting. Magnetic shelving. Graphite finish.



**Caddy Grip**  
Contenitore sospeso.  
Suspended cabinet.



**Caddy Grip**  
Vetrinetta sospesa.  
Suspended glass cabinet.



**Caddy Grip**  
Contenitore aperto.  
Open storage unit.



**Cart**  
Mensola magnetica. Magnetic shelf.







Pannelli fonoassorbenti integrati al sistema Caddy. Superficie in metallo perforato e anima in materiale altamente fonoassorbente, riciclabile e ignifugo.

Caddy compatible sound absorbing panels. Perforated metal surface with a sound-absorbing inside, made of recyclable and fire-retardant material.



**Caddy Shut App**  
Pannello fonoassorbente in metallo.  
Sound absorbing metal panel.

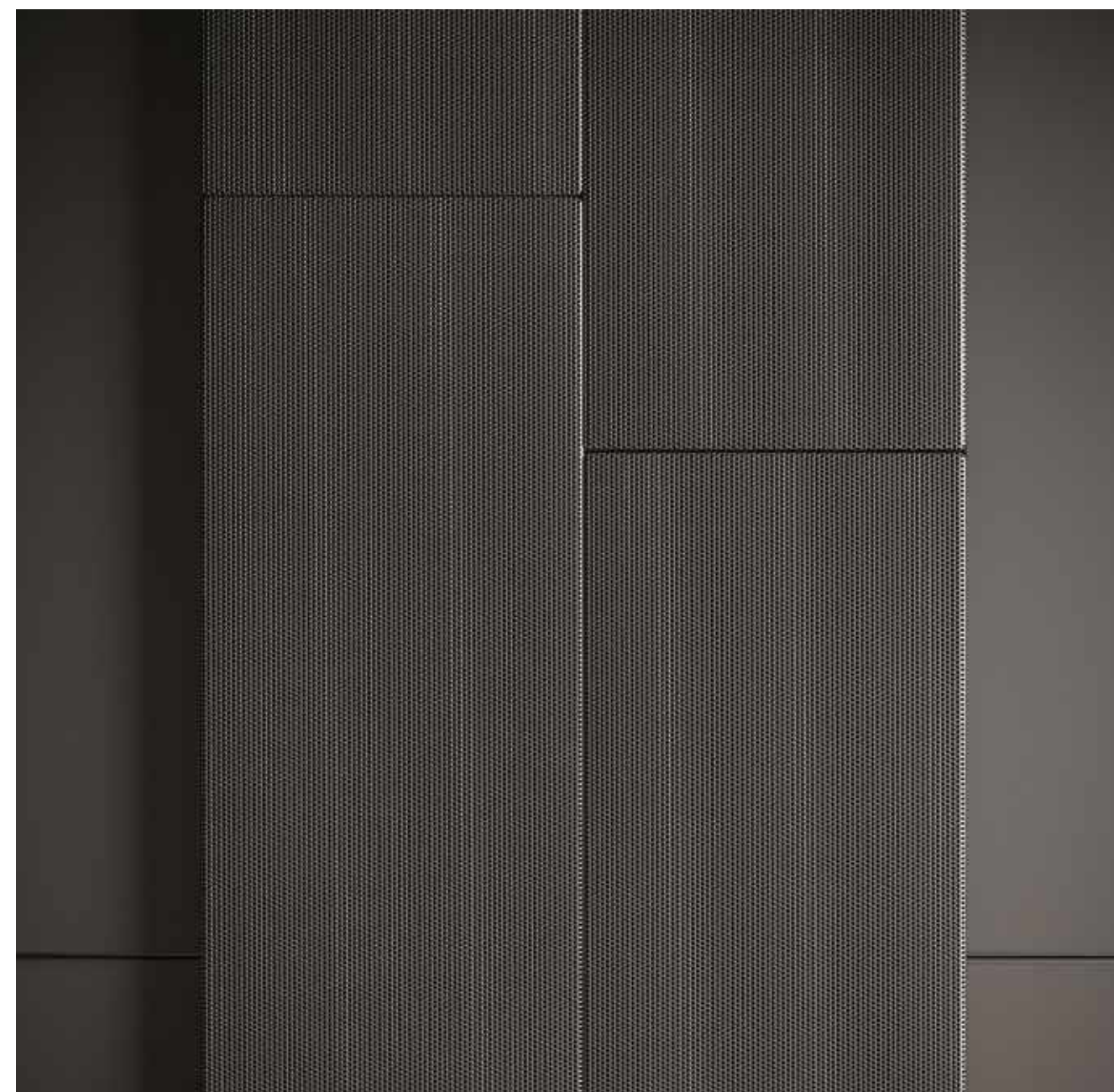









**Caddy** design: Gino Carollo

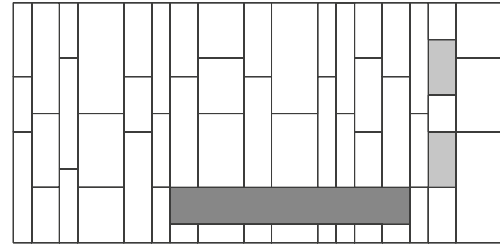

Composition 03  
L 5300 H 2600 P 300 mm

Boiserie composta da pannelli in metallo verniciato con vetrinette pensili integrate e mensole magnetiche. Finitura peltro. Dettaglio in basso in finitura nero.

Wall metal paneling with integrated glass cabinets and magnetic shelving. Pewter finish. Detail of black finished cabinet in picture below.



**Caddy Grip**  
Vetrinetta pensile sospesa.  
Suspended glass cabinet.



**Porta TV**  
Porta Tv magnetico. Magnetic TV mount.



**Swing**  
Vaschetta magnetica. Magnetic container.



**Cart**  
Mensola magnetica. Magnetic shelf.













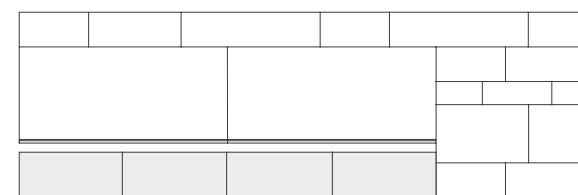



**Caddy** design: Gino Carollo



Composition 04  
L 5000 H 1600 P 480 mm

Boiserie composta da pannelli in metallo verniciato e ripiano porta TV in noce Canaletto. Mensole magnetiche in vetro e metallo. Basi rivestite in metallo. Finitura nero.

Wall metal paneling and veneered TV stand in American walnut finish. Metal and glass magnetic shelving. Metal covered base drawers. Black finish.

-  **Bench**  
Ripiano porta TV con schienale magnetico. TV stand with magnetic back panel.
-  **Glax**  
Mensola magnetica in vetro. Glass magnetic shelf.
-  **Swing**  
Vaschetta magnetica. Magnetic container.
-  **Cart**  
Mensola magnetica. Magnetic shelf.
-  **Iron**  
Base contenitore. Base storage unit.











**Caddy** design: Gino Carollo

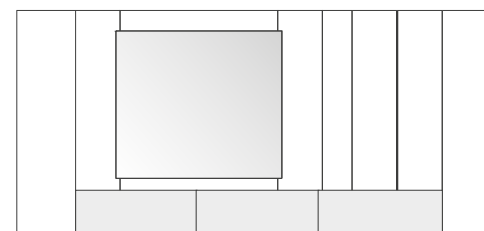

Composition 05  
L 3714 H 2200 P 20 mm

Boiserie composta da pannelli in metallo verniciato e pannelli rivestiti in ceramica. Specchio TV con retroilluminazione led opzionale. Mensole magnetiche con ripiano in vetro luminoso. Basi rivestite in metallo. Finiture: peltro e ceramica Statuario.

Wall metal paneling including ceramic coated panels. Mirror TV with optional back lighting. Magnetic shelves with illuminated glass ledge. Metal covered base drawers. Finishes: pewter and Statuario ceramic.



**Frame Light**  
Mensola magnetica luminosa.  
Magnetic illuminated shelf.



**Mr Hyde**  
Specchio TV. Mirror TV.



**Iron**  
Base contenitore. Base storage unit.





**Caddy** design: Gino Carollo

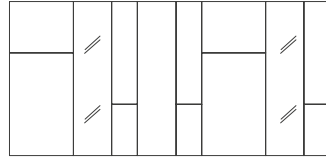

Composition 06  
L 2500 H 1200 P 20 mm

Boiserie composta da pannelli in metallo verniciato, moduli specchio e mensole magnetiche. Finitura ottone.

Wall metal paneling including mirror panels and magnetic shelving. Brass finish.



**Cart**  
Mensola magnetica. Magnetic shelf.





Flat design: Ronda Design Lab

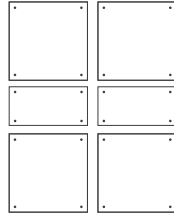

Composition 07  
L 1850 H 2350 P 1,5 mm

Composizione di lamiere di ferro verniciato e mensole magnetiche. Finitura titanio e noce Canaletto.

Wall paneling composed of flat metal sheets and magnetic shelves. Titanium and American walnut finish.

 L  
Mensola magnetica. Magnetic shelf.

 T  
Mensola magnetica. Magnetic shelf.

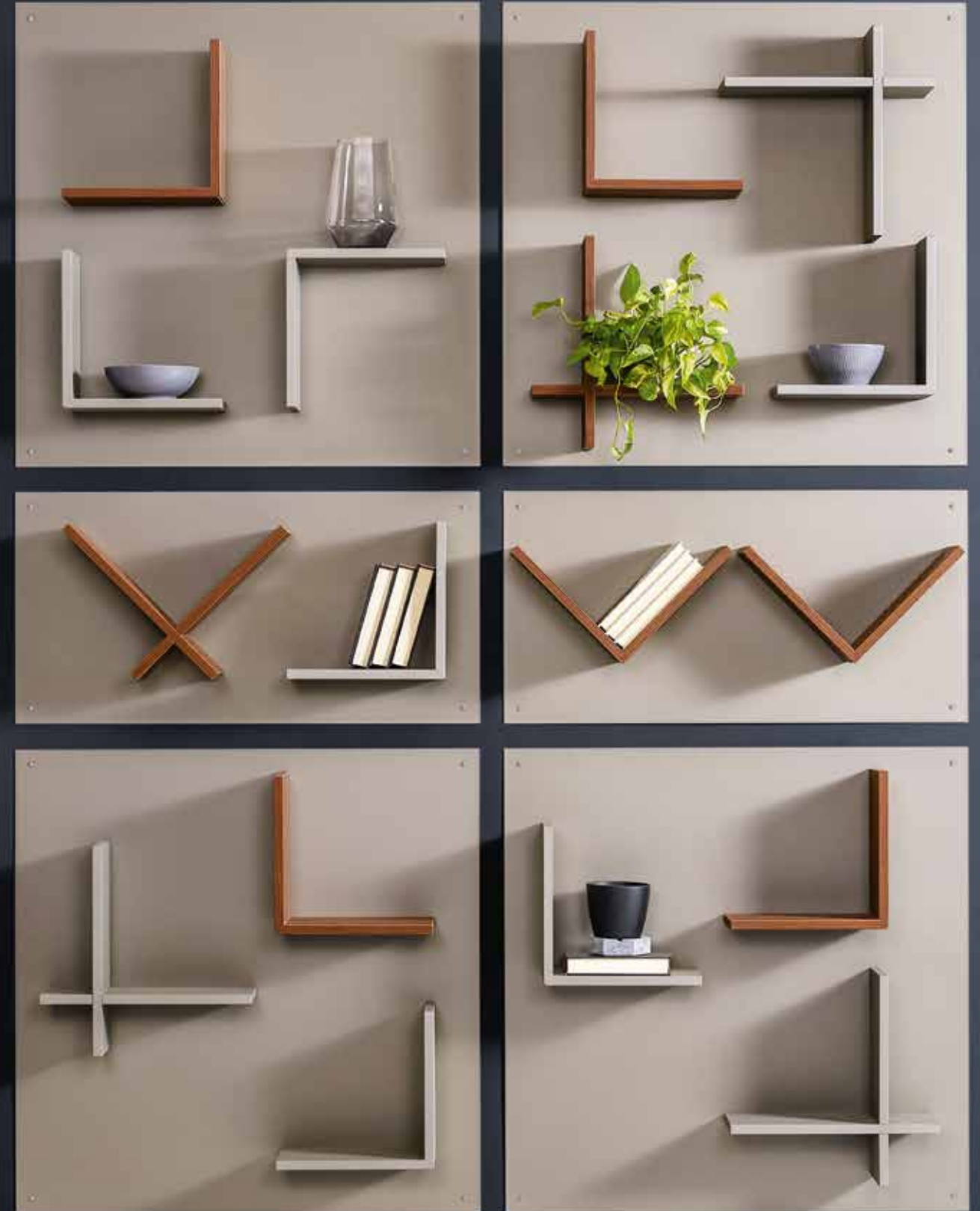





**Basic** design: Ronda Design Lab

Pannelli in metallo verniciato nelle finiture nero, grafite e titanio.  
Mensole magnetiche abbinata.

Wall metal panels with magnetic shelving.  
Black, graphite and titanium finish.



Composition 08  
L 3000 H 1440 P 20 mm



Composition 09  
L 1620 H 720 P 20 mm

 **Cubo**  
Mensola magnetica. Magnetic shelf.

 **Rettangolo**  
Mensola magnetica. Magnetic shelf.

 **Y**  
Mensola magnetica. Magnetic shelf.

 **T**  
Mensola magnetica. Magnetic shelf.



**Basic** design: Ronda Design Lab



Composition 10  
L 720 H 1620 P 20 mm







**Flat** design: Ronda Design Lab

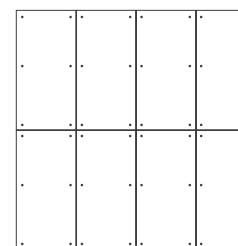

Composition 11  
L 2800 H 2900 P 1,5 mm

Boiserie composta da fogli di lamiera in finitura bianco. Composizione di elementi magnetici esagonali in finitura azzurro chiaro: pannelli fonoassorbenti e mensole a specchio con ripiano in cristallo.

Wall cladding composed of flat metal sheets in white finish. Magnetic combination of hexagonal items in light blue finish: acoustic panels and shelves with back mirror and crystal ledge.

 **Paddle**  
Pannello fonoassorbente.  
Sound absorbing panel.



 **Esagono**  
Mensola magnetica. Magnetic shelf.





**Caddy** design: Gino Carollo

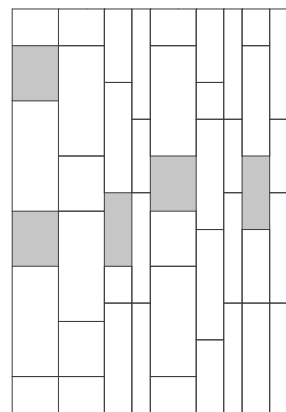

Composition 12  
L 3000 H 4400 P 60 mm

Boiserie composta da pannelli in metallo verniciato intervallati da elementi speciali luminosi. Mensole magnetiche in metallo. Finitura bianco.

Wall metal paneling including dedicated modules with led lighting and magnetic shelving. White finish.

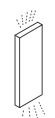

**Caddy light**  
Pannello con fasce led integrate.  
Metal panel with integrated led stripes.



**Ellix Cart**  
Mensola magnetica. Magnetic shelf.



**Ellix Swing**  
Vaschetta magnetica. Magnetic container.

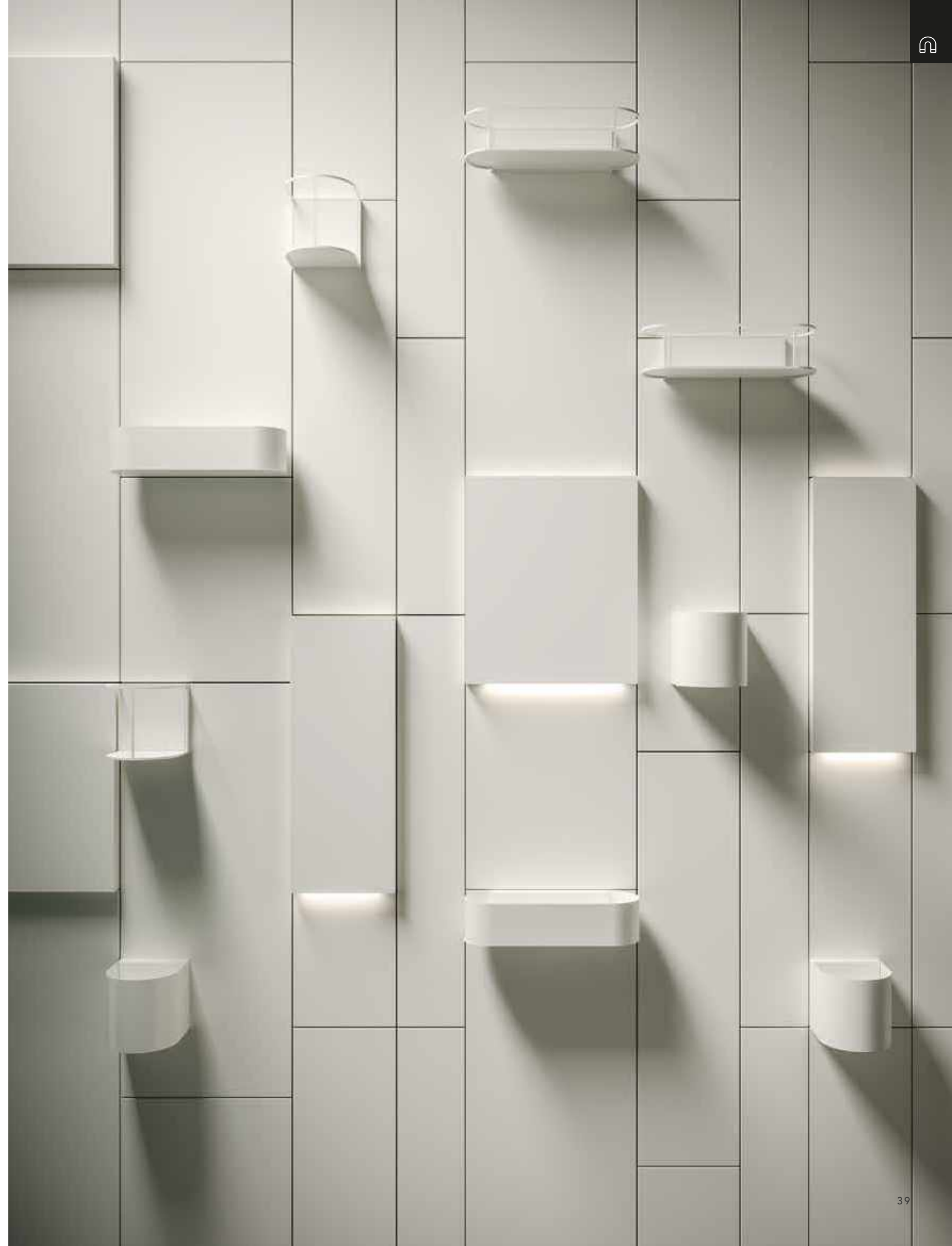







**Flat** design: Ronda Design Lab

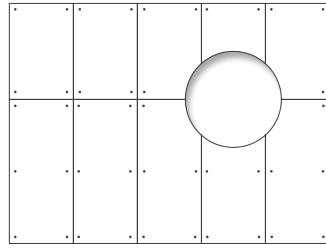

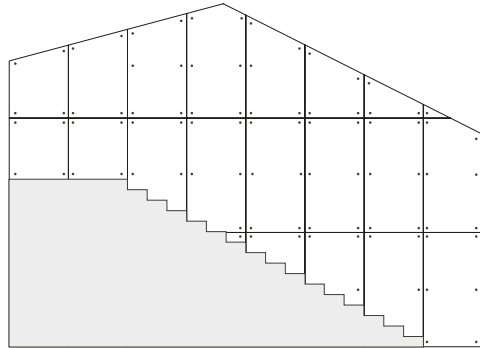

Composition 13  
L 4000 H 3000 P 1,5 mm



Composition 14  
L 8000 H max 5799 P 1,5 mm

Boiserie composta da fogli di lamiera verniciati nelle finiture titanio e nero. Pannelli fonoassorbenti magnetici in tessuto verde salvia. Specchi magnetici con cornice in metallo.

Wall cladding composed of flat metal sheet, titanium and black finish. Magnetic sound absorbing panels covered with sage green fabric. Metal framed magnetic mirrors.

-  **Paddle**  
Pannello fonoassorbente magnetico.  
Magnetic sound absorbing panel.
-  **Snow**  
Specchio magnetico. Magnetic mirror.











**Caddy** design: Gino Carollo

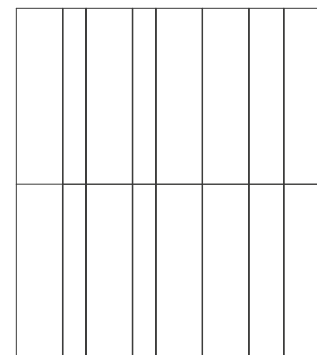

Composition 15  
L 3915 H 4400 P 20 mm

Boiserie composta da pannelli in metallo verniciato grafite.  
Mensole magnetiche con ripiano in vetro luminoso.  
Dettagli in basso in finitura bronzo.

Wall metal paneling in graphite finish. Magnetic shelving  
with illuminated glass ledges. Pictures below in bronze  
finish.



**Frame Light**  
Mensole magnetica luminosa.  
Magnetic illuminated shelf.





**Caddy** design: Gino Carollo

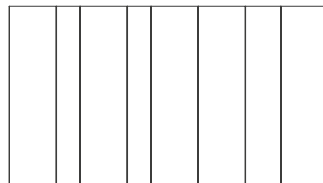

Composition 16  
L 3914 H 2200 P 20 mm

Boiserie composta da pannelli in metallo verniciato grafite.  
Mensole magnetiche e specchi magnetici retroilluminati.  
Madia magnetica finitura grafite e ceramica Statuario.

Wall metal paneling in graphite finish. Magnetic shelving  
and backlit mirrors. Metal and ceramic magnetic  
sideboard, graphite and Statuario finish.



 **Clip**  
Mensola magnetica. Magnetic shelf.

 **Snow**  
Specchio magnetico. Magnetic mirror.

 **Bermuda**  
Madia magnetica. Magnetic sideboard.

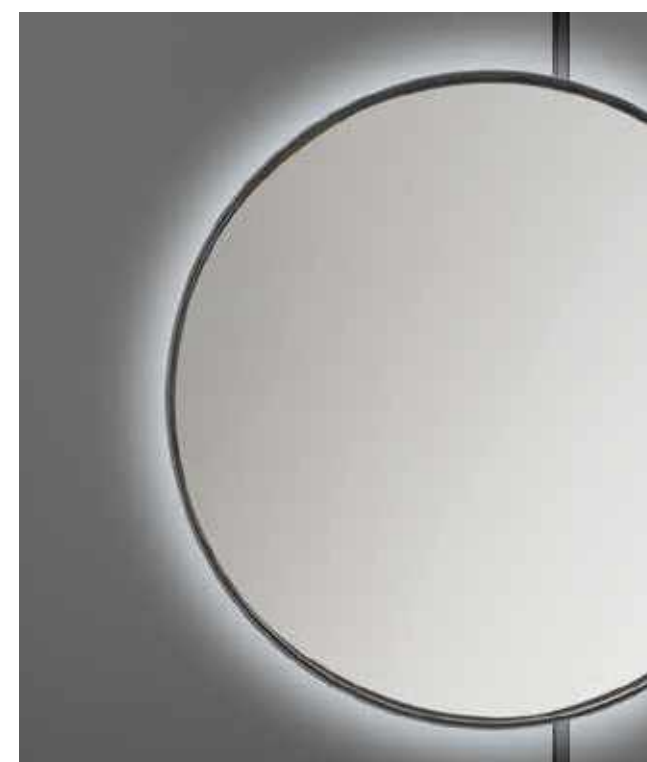









**Caddy** design: Gino Carollo

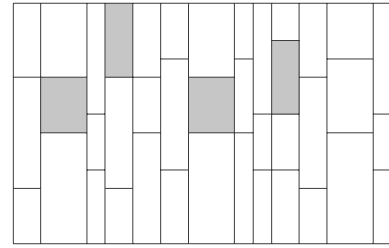

Composition 17  
L 4100 H 2600 P 60 mm

Boiserie composta da pannelli in metallo verniciato intervallati da elementi speciali luminosi. Mensole magnetiche in metallo. Finitura rame brunito.

Wall metal paneling including dedicated modules with led lighting and magnetic shelving. Aged copper finish.



**Caddy light**  
Pannello con fasce led integrate.  
Metal panel with integrated led stripes.



**Swing**  
Vaschetta magnetica. Magnetic container.



**Cart**  
Mensola magnetica. Magnetic shelf.





**Caddy** design: Gino Carollo

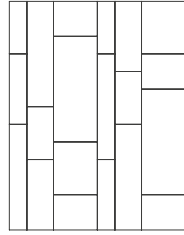

Composition 18  
L 2000 H 2600 P 20 mm

Boiserie composta da pannelli in metallo verniciato, mensole e vaschette magnetiche. Finitura titanio.

Wall metal paneling with magnetic shelving. Titanium finish.



**Swing**  
Vaschetta magnetica. Magnetic container.



**Cart**  
Mensola magnetica. Magnetic shelf.







**Caddy** design: Gino Carollo

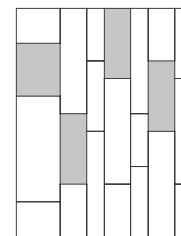

Composition 19  
L 2000 H 2600 P 60 mm

Boiserie composta da pannelli in metallo intervallati da moduli dedicati luminosi e mensole magnetiche. Finitura nero.

Wall metal paneling including dedicated modules with led lighting and magnetic shelving. Black finish.

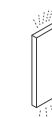

**Caddy light**  
Pannello con fasce led integrate.  
Metal panel with integrated led stripes.



**Cart**  
Mensola magnetica. Magnetic shelf.



**Swing**  
Vaschetta magnetica. Magnetic container.





**Caddy** design: Gino Carollo

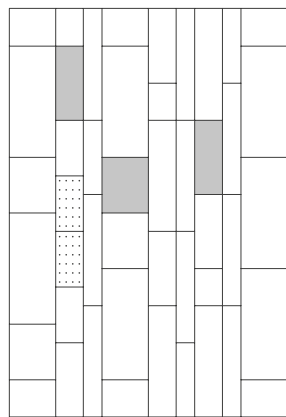

Composition 20  
L 3000 H 4400 P 190 mm

Boiserie composta da pannelli in metallo verniciato intervallati da alcuni elementi speciali: pannelli sporgenti luminosi e pannelli con perni portabottiglie. Mensole e portabottiglie magnetici. Finiture: nero e rovere naturale.

Wall metal paneling including dedicated modules with led lighting and bottle holders. Magnetic shelves and wine bar accessories. Finishes: black and natural oak.

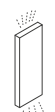

**Caddy light**  
Pannello con fasce led integrate.  
Metal panel with integrated led stripes.



**Caddy bottle**  
Modulo portabottiglie. Bottle holder module.



**Bet**  
Portabottiglie magnetico. Magnetic bottle holder.



**Blade**  
Mensola magnetica. Magnetic shelf.



**Blade**  
Portacalici magnetico. Magnetic wine glass holder.



**H**  
Portacalici magnetico. Magnetic wine glass holder.



**Swing**  
Vaschetta magnetica. Magnetic container.







**Flat** design: Ronda Design Lab

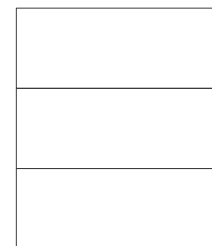

Composition 21  
L 2000 H 3000 P 1,5 mm

Boiserie composta da fogli di lamiera in ferro naturale. Mensole e portabottiglie magnetici in finitura antracite e rovere naturale.

Wall cladding composed of flat metal sheets in natural iron finish. Magnetic shelving and bottle holders in charcoal and natural oak finish.

  **Rettangolo bottle**  
Portabottiglie magnetico. Magnetic bottle holder.

  **L bottle**  
Portabottiglie magnetico. Magnetic bottle holder.

  **Box**  
Portabottiglie magnetico. Magnetic bottle holder.

  **Open Box**  
Portabottiglie magnetico. Magnetic bottle holder.











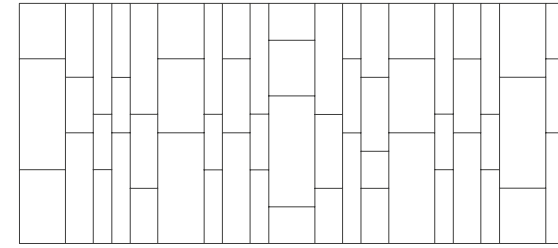

**Caddy** design: Gino Carollo



Composition 22  
L 6000 H 2600 P 20 mm

Boiserie composta da pannelli in metallo e pannelli rivestiti in ceramica. Mensole e accessori magnetici in metallo. Finiture: tortora e Étoile crema.

Wall paneling composed of metal elements and ceramic coated panels. Magnetic shelving and accessories. Finishes: taupe and Étoile cream.

 **Ellix Cart**  
Mensola magnetica. Magnetic shelf.

 **Ellix Swing**  
Vaschetta magnetica. Magnetic container.





**Caddy** design: Gino Carollo

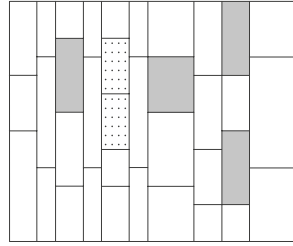

Composition 23  
L 3100 H 2600 P 190 mm

Boiserie composta da pannelli in metallo in finitura tortora intervallati da alcuni elementi dedicati: pannelli sporgenti luminosi e pannelli con perni portabottiglie.

Wall metal paneling including dedicated modules with led lighting and bottle holders. Taupe finish.

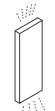

**Caddy light**  
Pannello con fasce led integrate.  
Metal panel with integrated led stripes.



**Caddy bottle**  
Modulo portabottiglie. Bottle holder module.



**Olo**  
Portabottiglie magnetico. Magnetic bottle holder.









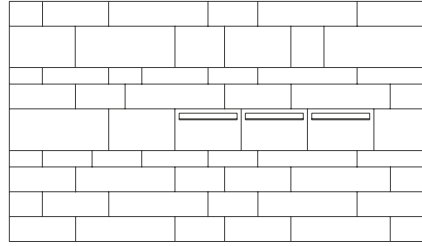

**Caddy** design: Gino Carollo





Composition 24  
L 5000 H 2900 P 20 mm

Boiserie composta da pannelli in metallo verniciato con elementi impiattati e pannelli con fessura luminosa. Mensole e accessori magnetici. Finiture: nero e noce Canaletto.

Wall paneling composed of metal elements and veneered panels, including dedicated modules with led lighting. Magnetic shelving and accessories. Finishes: black and American walnut.

 **Caddy Post**  
Pannello in metallo con led. Metal panel with led.

 **Cart**  
Mensola magnetica. Magnetic shelf.

 **Prisma**  
Vaschetta magnetica. Magnetic container.

 **L bottle**  
Portabottiglie magnetico. Magnetic bottle holder.











**Caddy** design: Gino Carollo

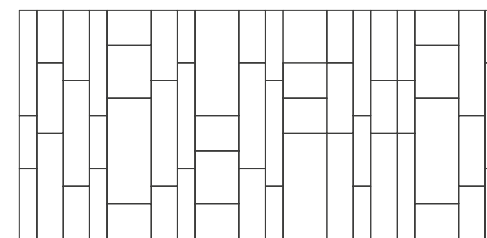

Composition 25  
L 5500 H 2600 P 20 mm

Boiserie composta da pannelli in metallo verniciato e mensole magnetiche in metallo. Finiture: nero e ottone.

Wall metal paneling and magnetic shelving. Finishes: black and brass.

 **Swing**  
Vaschetta magnetica. Magnetic container.

 **Cart**  
Mensola magnetica. Magnetic shelf.











**Caddy** design: Gino Carollo

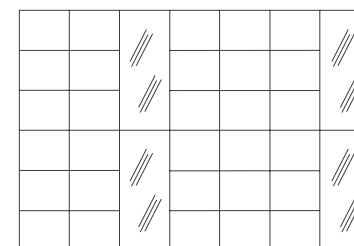

Composition 26  
L 3500 H 2400 P 60 mm

Boiserie composta da pannelli in metallo verniciato intervallati da elementi a specchio ed elementi obliqui con fascia led opzionale. Accessori magnetici per ingresso. Finitura nero.

Wall metal paneling including mirror modules and tilted modules with optional led lighting. Hallways dedicated magnetic accessories. Black finish.



**Caddy Tilt light**  
Pannello obliquo con fascia led.  
Tilted panel with optional led stripe.



**Caddy Tilt**  
Pannello obliquo.  
Tilted panel.



**Volée**  
Appendino magnetico.  
Magnetic hanger.



**Caddy rain**  
Portaombrelli magnetico.  
Magnetic umbrella stand.







**Flat** design: Ronda Design Lab

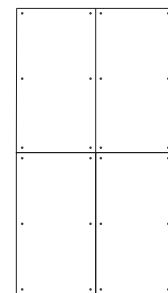

Composition 27  
L 1800 H 2340 P 1,5 mm

Composizione di lamiera di ferro verniciato in finitura nero.  
Accessori magnetici per ingresso finitura rame.

Wall cladding composed of flat metal sheets in black finish.  
Hallway dedicated magnetic accessories in copper finish.

 **Bottono**  
Appendiabiti magnetico. Magnetic hanger.







**Flat** design: Ronda Design Lab

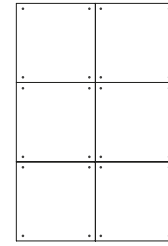

Composition 28  
L 1800 H 2700 P 1,5 mm

Composizione di lamiere di ferro verniciato in finitura bronzo. Mensole magnetiche in vetro. Lampada magnetica in finitura nero. Dettaglio in basso in finitura peltro.

Wall cladding composed of flat metal sheets in bronze finish. Glass shelves. Magnetic lamp in black finish. Picture below in pewter finish.

 **Brand**  
Lampada magnetica ricaricabile.  
Rechargeable magnetic lamp.

 **Glax**  
Mensola magnetica in vetro.  
Glass magnetic shelf.







**Caddy** design: Gino Carollo

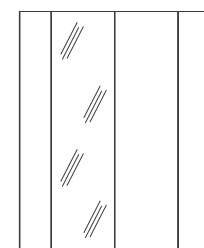

Composition 29  
L 1400 H 2200 P 20 mm

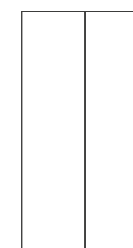



L 1000 H 2200 P 20 mm

Boiserie composta da pannelli in metallo rivestiti in ceramica e specchio fumé. Accessori magnetici e consolle. Finiture: Statuario e grafite. Dettagli in basso in finitura titanio.

Wall metal paneling composed of ceramic coated panels and smoked mirrors. Magnetic accessories and console. Finishes: Statuario ceramic and graphite. Pictures below in titanium finish.

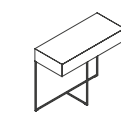
- 

**Volée**  
Appendino magnetico. Magnetic hanger.
- 

**Birdie**  
Consolle magnetica. Magnetic console.
- 

**Clip**  
Mensola magnetica. Magnetic shelf.







**Jazz** design: Studio 28



Composition 30  
L 2800 H 1300 P 49 mm

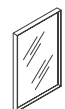

**Jazz mirror**  
Specchio magnetico. Magnetic mirror.



**Jazz coat hanger**  
Appendino magnetico. Magnetic coat hanger.



**Cart**  
Mensola magnetica. Magnetic shelf.



**Swing**  
Vaschetta magnetica. Magnetic container.



Soluzione ingresso composta da pannelli con bordi a 45° in metallo con retro-illuminazione led opzionale. Specchi e accessori magnetici. Finiture: nero e noce Canaletto.

Entrance hall solution composed of 45° edged metal panels with optional led back-lighting. Magnetic mirrors and accessories. Black and American walnut finish.







**Jazz** design: Studio 28

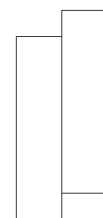

Composition 31  
L 1000 H 2200 P 34 mm

Soluzione ingresso composta da pannelli con bordi a 45° in metallo con retro-illuminazione led opzionale. Specchi e accessori magnetici. Finiture: ottone e noce Canaletto.

Entrance hall solution composed of 45° edged metal panels with optional led back-lighting. Magnetic mirrors and accessories. Brass and American walnut finish.

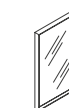

**Jazz mirror**  
Specchio magnetico. Magnetic mirror.



**Jazz coat hanger**  
Appendino magnetico. Magnetic coat hanger.



**Swing**  
Vaschetta magnetica. Magnetic container.











Caddy design: Gino Carollo

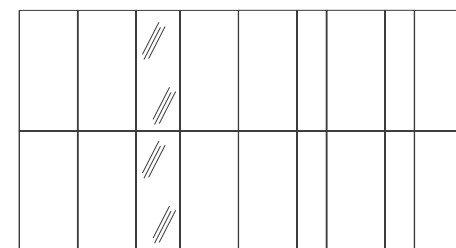

Composition 32  
L 3700 H 2400 P 20 mm

Boiserie composta da pannelli in metallo con moduli specchio. Pannelli, comodino, basi e accessori magnetici in finitura grafite. Giroletto e testiera magnetica componibile in pelle asfalto. Dettaglio in basso in finitura bronzo e Étoile crema.

Wall metal paneling in graphite finish with mirror. Bedside table, base storage units and magnetic accessories in graphite finish. Leather bedframe and magnetic modular headboard in asphalt finish. Picture below in bronze and Étoile cream finish.

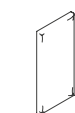

**Bounce**  
Testiera magnetica.  
Magnetic headboard.



**Bogey**  
Comodino magnetico.  
Magnetic bedside table.



**Glax**  
Mensola magnetica in vetro.  
Glass magnetic shelf.



**Clip**  
Mensola magnetica.  
Magnetic shelf.













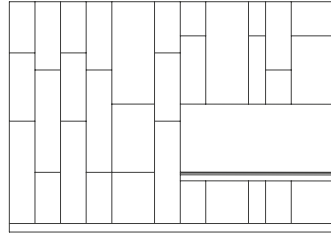



**Caddy** design: Gino Carollo



Composition 33  
L 3800 H 2700 P 480 mm

Boiserie composta da pannelli in metallo verniciato e scrivania sospesa integrata. Giroletto e testiera magnetica componibile in velluto. Lampada e mensole magnetiche. Finiture: tortora e verde.

Wall metal paneling with integrated suspended desk. Velvet bedframe and magnetic modular headboard. Magnetic lamp and shelving. Taupe and light green finish.

-  **Bounce**  
Testiera magnetica. Magnetic headboard.
-  **Bench**  
Scrivania con schienale in metallo. Desk with metal back panel.
-  **Clip**  
Mensola magnetica. Magnetic shelf.
-  **Y shelf**  
Mensola magnetica. Magnetic shelf.
-  **Lapilla**  
Lampada magnetica ricaricabile. Rechargeable magnetic lamp.







**Flat** design: Ronda Design Lab

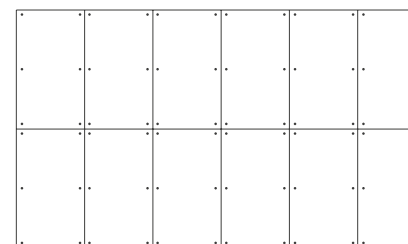

Composition 34  
L 4800 H 2800 P 1,5 mm

Composizione di lamiere di ferro verniciato. Pannelli fonoassorbenti magnetici in tessuto e appendiabiti magnetici. Finitura verde.

Wall cladding composed of flat metal sheets with magnetic hangers and sound-absorbing panels. Light green finish.

**Paddle**  
Pannello magnetico fonoassorbente.  
Magnetic sound absorbing panel. 

**Bottone**  
Appendiabiti magnetico. Magnetic hanger. 





**Caddy** design: Gino Carollo

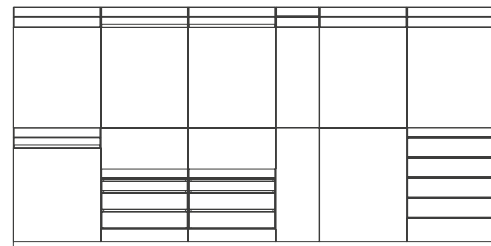



Composition 35  
L 4800 H 2400 P 520 mm

Cabina armadio in metallo con fissaggio a cremagliera composta da pannelli, cassettiere sospese, mensole con barra appendiabiti e pannelli led opzionali. Accessori magnetici in vetro e metallo. Finitura grafite.

Metal walk-in closet with rack fixing composed of panels, suspended chest of drawers, shelves with optional hanging bar and led panels. Magnetic accessories in glass and metal. Graphite finish.

 **Frame**  
Mensola magnetica. Magnetic shelf.

 **Frame Coat**  
Mensola magnetica con ganci. Magnetic shelf with pins.

 **Glax**  
Mensola magnetica in vetro. Glass magnetic shelf.

 **Volée**  
Appendino magnetico. Magnetic hanger.







**Caddy** design: Gino Carollo

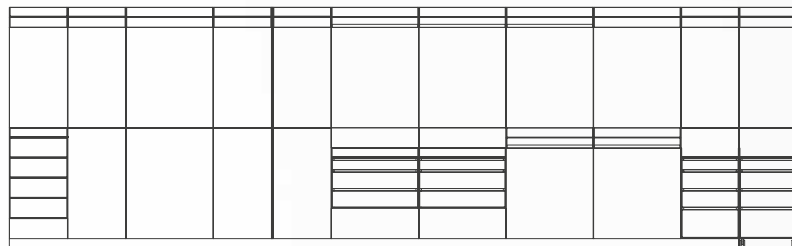

Composition 36  
L 7500 H 2400 P 520 mm

Cabina armadio in metallo con fissaggio a cremagliera composta da pannelli, specchiere, cassettiere a terra e sospese, mensole con barra appendiabiti e pannelli led opzionali. Accessori magnetici in vetro e metallo. Finitura grafite.

Metal walk-in closet with rack fixing, composed of panels and mirrors, floor and suspended chest of drawers, shelves with optional hanging bar and led panels. Magnetic accessories in glass and metal. Graphite finish.

 **Hat**  
Porta cappelli magnetico. Magnetic hat hanger.

 **Volée**  
Appendino magnetico. Magnetic hanger.

 **Clip**  
Mensola magnetica. Magnetic shelf.

 **Frame Light**  
Mensola magnetica luminosa. Illuminated magnetic shelf.

 **Glax**  
Mensola magnetica in vetro. Glass magnetic shelf.

 **Frame**  
Mensola magnetica. Magnetic shelf.

 **Swing**  
Vaschetta magnetica. Magnetic container.

 **Tie**  
Porta cravatte magnetico. Magnetic tie rack.











**Caddy** design: Gino Carollo

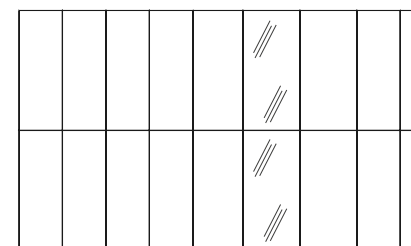

Composition 37  
L 4500 H 2400 P 20 mm

Boiserie composta da pannelli in metallo e pannelli rivestiti in ceramica o specchio. Mensole e accessori bagno magnetici componibili. Finiture: ottone e nero Marquinia.

Wall metal paneling composed of metal elements and ceramics or mirror coated panels. Magnetic shelves and modular bathroom accessories. Finishes: brass and black Marquinia.



**Volée**  
Appendino magnetico. Magnetic hanger.



**Glax**  
Mensola magnetica in vetro. Glass magnetic shelf.



**Caddy Warm App**

Pannello riscaldante in metallo, utilizzabile singolarmente oppure all'interno di una composizione di pannelli Caddy. Superficie idonea all'applicazione di accessori magnetici di tipo 1.0. Temperatura massima 60 °C. Alimentazione elettrica a 220 V. Integrabile al sistema di riscaldamento centralizzato.

Metal heating panel, to be mounted individually or within a composition of Caddy panels. Its surface is suitable for the application of magnetic accessories type 1.0. Maximum temperature 60 °C. 220 V power supply. Can be integrated into the central heating system.

Dimensioni \_ Dimensions  
P 20 mm

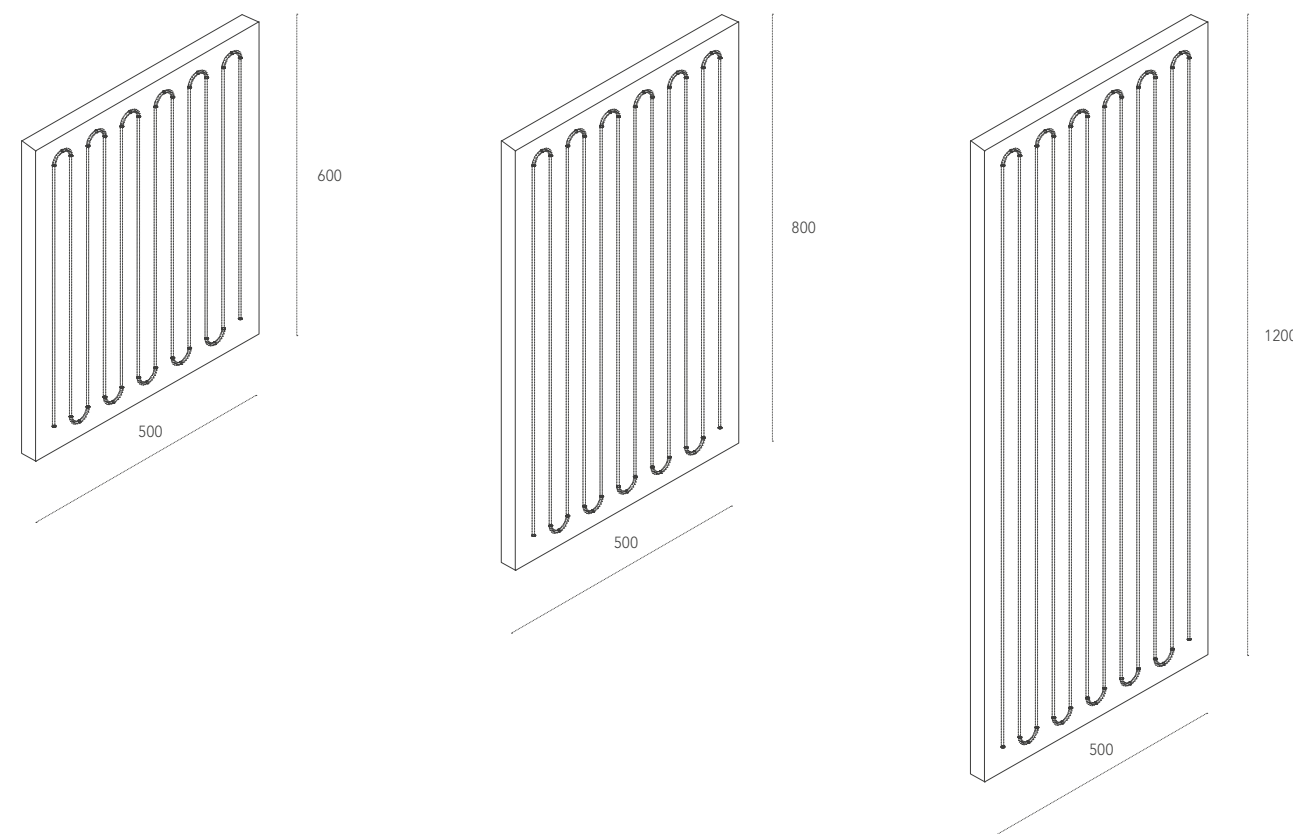



**Bain** design: Studio 28

Accessori bagno magnetici modulari. Combinando la struttura in metallo con i diversi ripiani ed i contenitori in ceramica, il porta salviette si trasforma in mensola, porta rotoli, porta-gioie e porta-spazzolini.

Magnetic modular bathroom accessories. By combining the metal structure with the different shelves and ceramic containers, the towel rack turns into a shelf, a toilet paper holder, a jewellery holder and a toothbrush holder.





# Flat

**Pannelli di lamiera di ferro con uno spessore di 1,5 mm da fissare a parete con viti. Disponibili con modularità standard o su misura. Pannelli compatibili con tutti gli accessori magnetici.**

Iron sheet panels (1,5 mm thick) to be mounted to the wall with screws. Available in standard modularity or custom sized. Compatible with all the magnetic accessories.

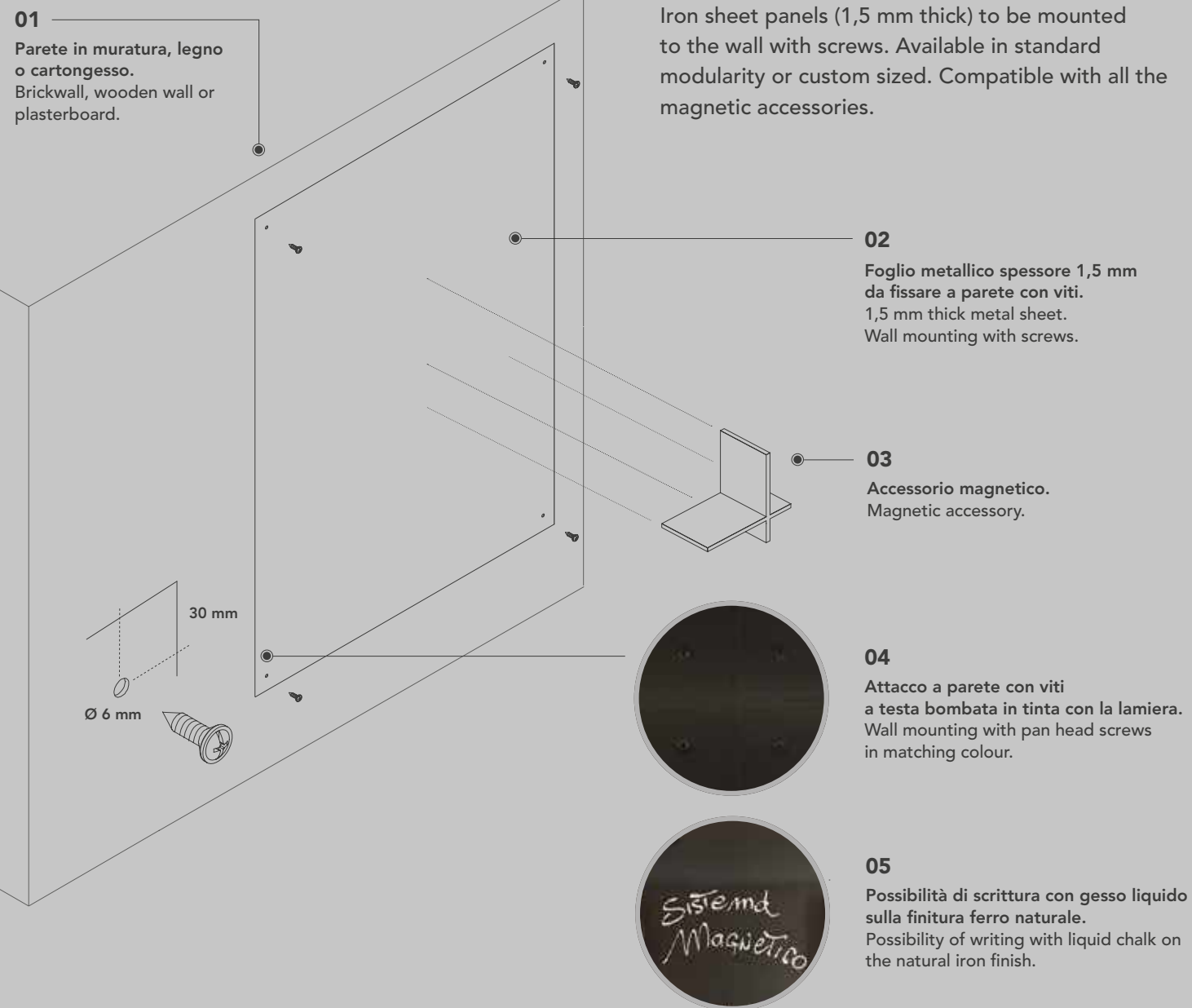

## Materiali \_ Materials



**Ferro naturale**  
Natural iron



**Metallo verniciato a polveri**  
Powder coated metal



**Metallo brunito**  
Burnished metal

## Modularità \_ Modularity

Lamiere standard \_ Standard sized metal sheets  
Profondità \_ Depth 1,5 mm

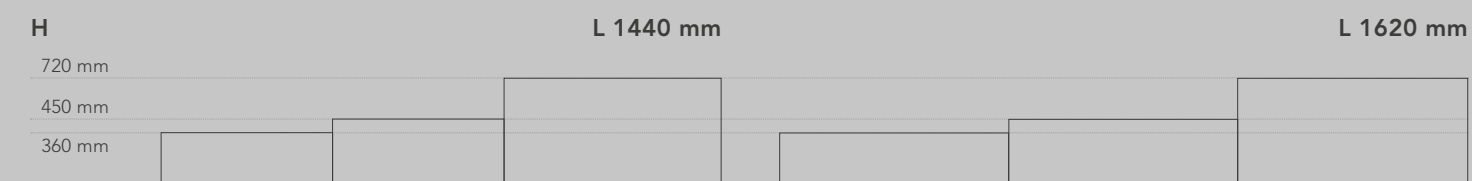
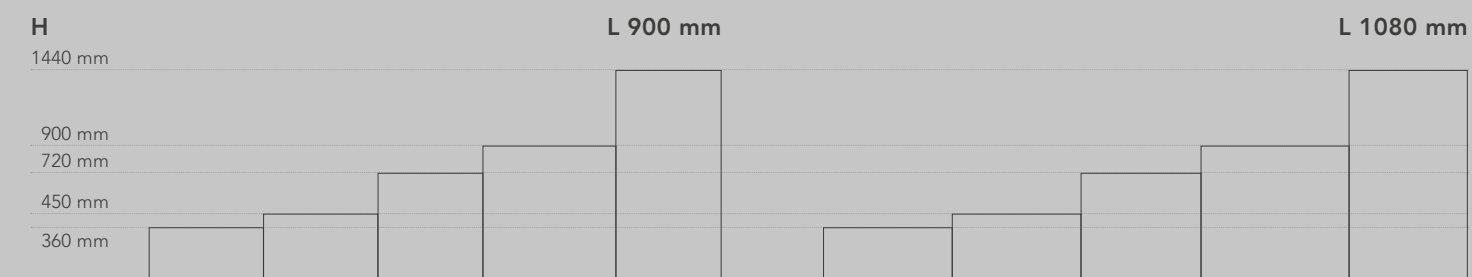

## Applicazioni \_ Applications



**Schienale cucina**  
Kitchen backsplash

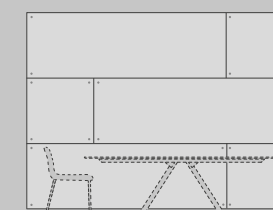

**Rivestimento parete**  
Wall cladding

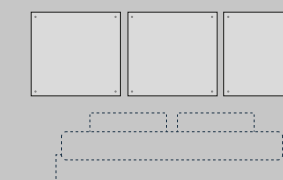

**Pannelli singoli**  
Single panels

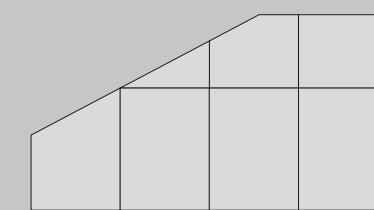

**Taglio su misura**  
Tailor shaped

## Taglio su misura \_ Tailor made



Misura massima della lamiera **2000 x 1400 mm**  
Maximum size for metal sheets

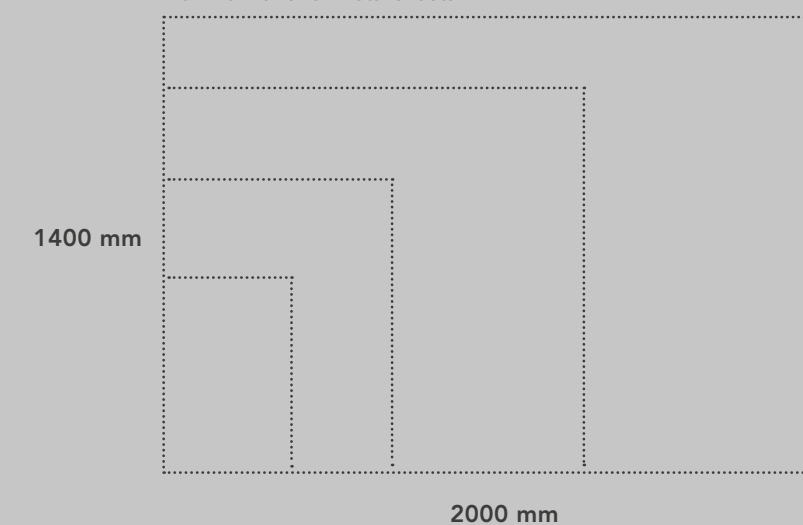



# Caddy

**Boiserie decorativa e funzionale formata da pannelli in metallo, legno, ceramica o specchio. L'anima metallica dei pannelli permette di applicare una vasta gamma di accessori magnetici, creando illimitate composizioni adatte ad ogni ambiente ed esigenza.**

Decorative and functional wall paneling system composed of metal, wood, ceramic or mirror panels. The panels' metal core makes them compatible with a wide range of magnetic accessories, thus enabling the creation of unlimited compositions suitable for every environment and need.

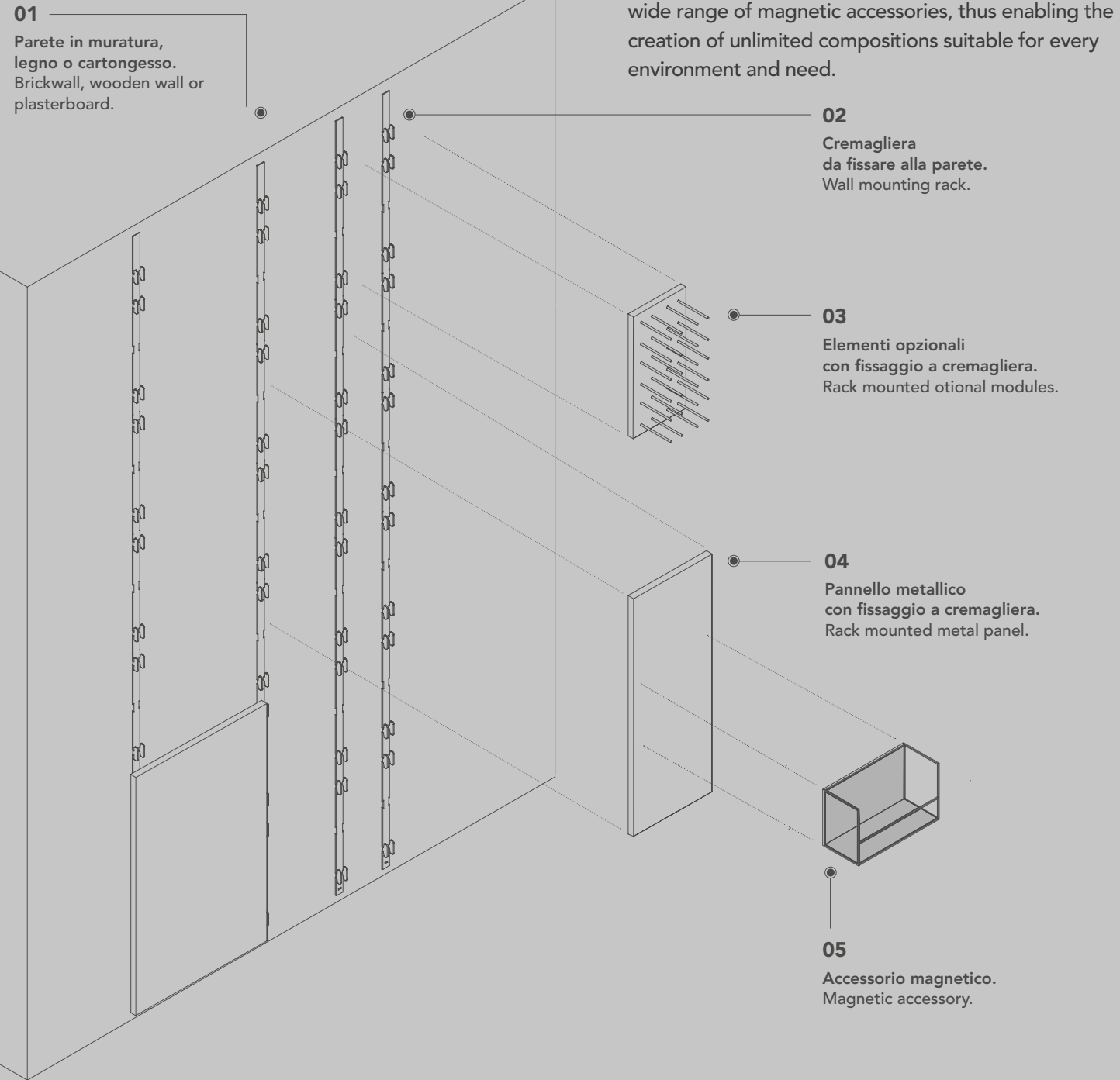

## Modularità \_ Modularity

Pannelli standard \_ Standard sized metal panels  
Profondità \_ Depth 20 mm

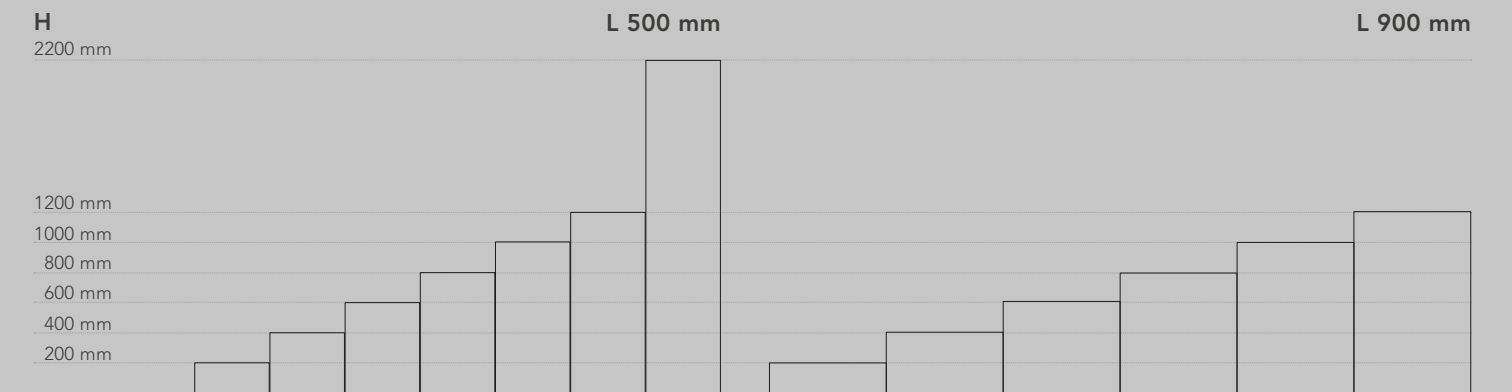
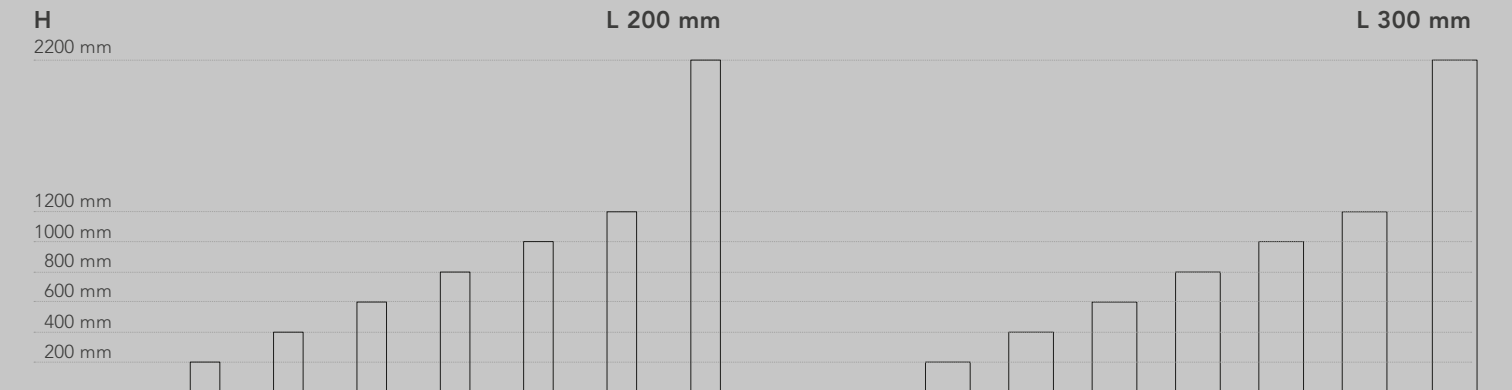

Kit standard di pannelli \_ Standard panel sets  
Profondità \_ Depth 20 mm

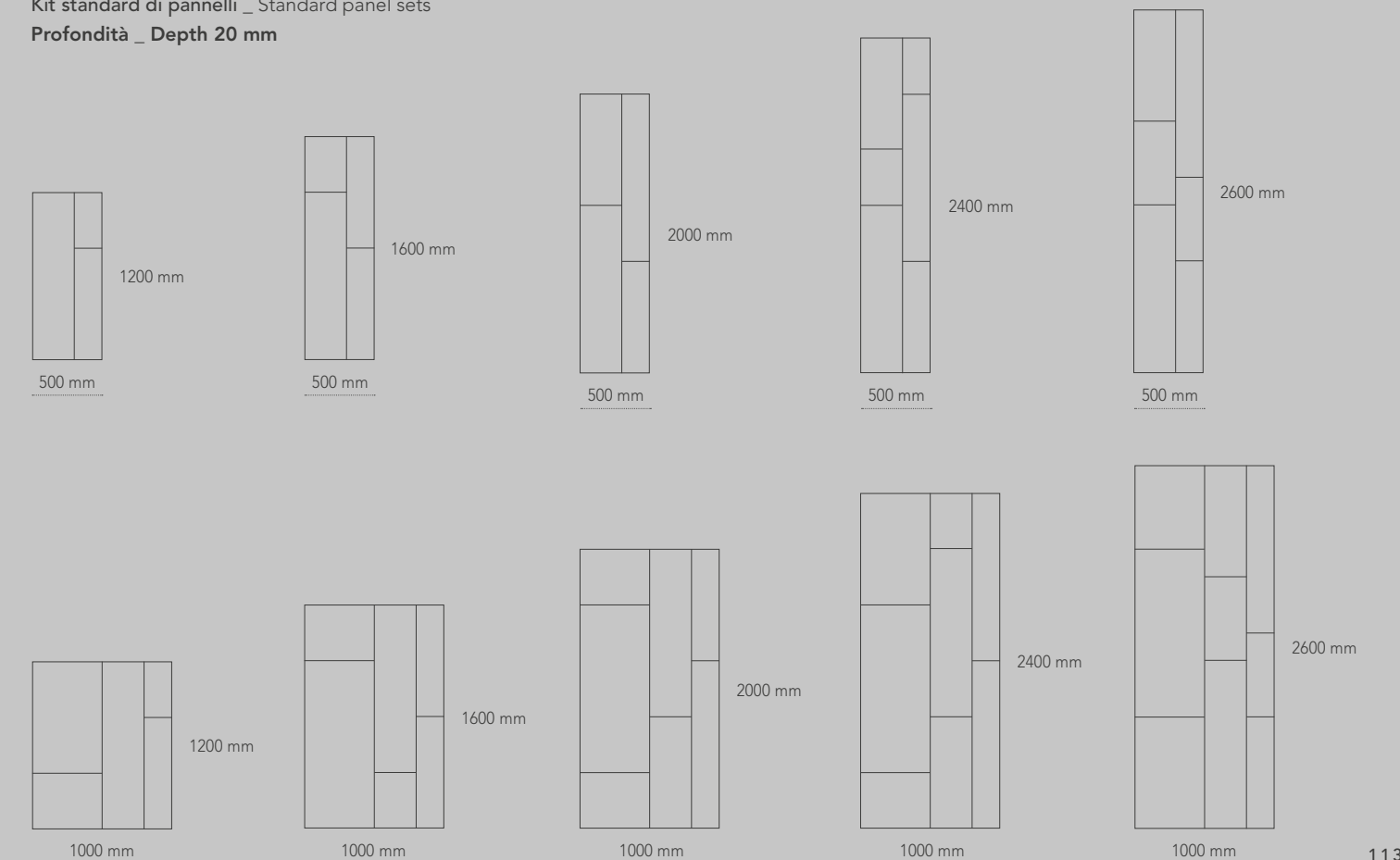





## Materiali \_ Materials

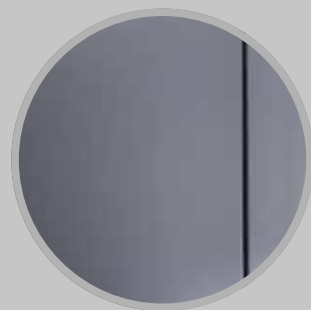

**Metallo verniciato a polveri**  
Powder coated metal



**Metallo brunito**  
Burnished metal

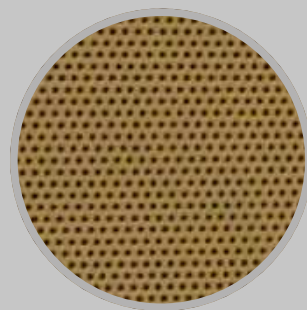

**Metallo perforato**  
Perforated metal



**Legno**  
Veneered



**Ceramica**  
Ceramics

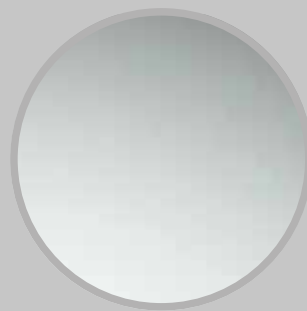

**Specchio**  
Mirror

## Applicazioni \_ Applications

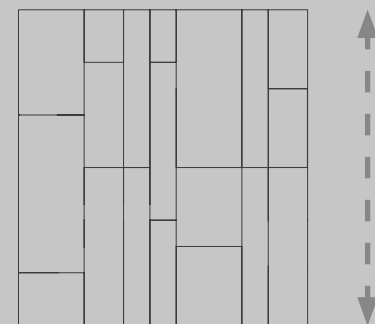

**Pannelli posizionati in verticale**  
Vertically mounted panels

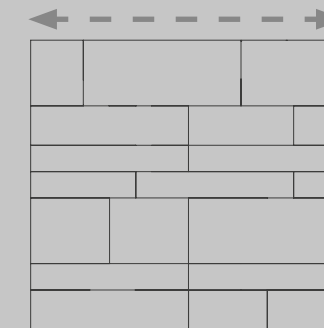

**Pannelli posizionati in orizzontale**  
Horizontally mounted panels

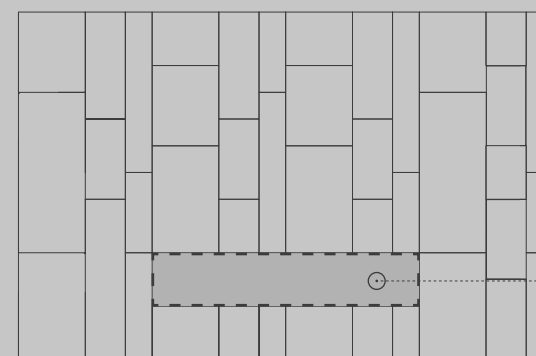

**Esempio applicazione con vano camino**  
Example of application with chimney compartment



## Elementi opzionali \_ Optional modules

**Pannelli e contenitori con fissaggio a cremagliera**  
Rack mounted panels and cabinets



**Caddy LIGHT**  
Modulo con fasce led  
Module with led stripes

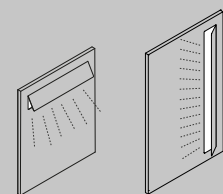

**Caddy POST**  
Modulo con finestra led  
Module with led slot

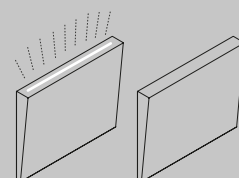

**Caddy TILT**  
Modulo obliquo  
Tilted module

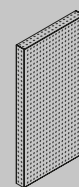

**Caddy SHUT APP**  
Modulo fonoassorbente  
Sound absorbing module

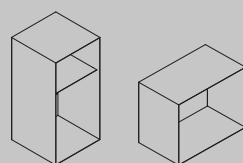

**Caddy GRIP**  
Pensile aperto  
Suspended unit

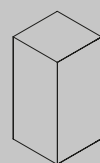

**Caddy GRIP**  
Pensile con anta  
Suspended cabinet

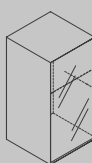

**Caddy GRIP**  
Pensile con anta vetro  
Suspended glass cabinet

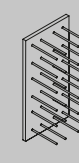

**Caddy BOTTLE**  
Modulo portabottiglie  
Bottle holder module

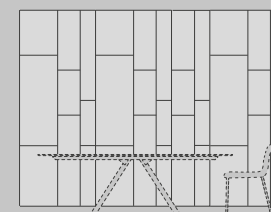

**Sala da pranzo**  
Dining room



**Zona giorno**  
Living room



**Studio**  
Home office

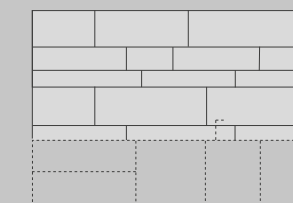

**Cucina**  
Kitchen

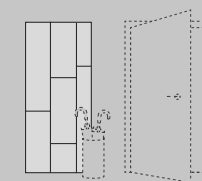

**Ingresso**  
Entrance hall



**Zona notte**  
Bedroom

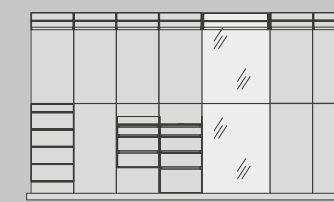

**Cabina armadio**  
Walk-in closet

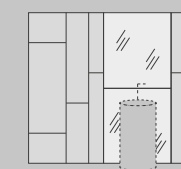









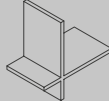

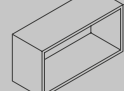
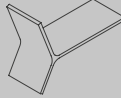

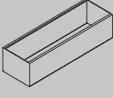
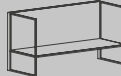
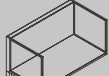

**Bagno**  
Bathroom

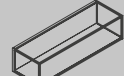
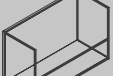

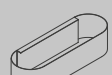

## Mensole Shelves

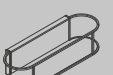
 <b>L</b> design: Ronda Design Lab L 300 H 300 P 150/220 mm	 <b>T</b> design: Ronda Design Lab L 400 H 400 P 150/220 mm	 <b>U</b> design: Ronda Design Lab L 300 H 300 P 220 mm	 <b>Cubo</b> design: Ronda Design Lab L 300 H 300 P 150/220 mm	 <b>Rettangolo</b> design: Ronda Design Lab L 600 H 300 P 150/220 mm	
 <b>Y</b> design: Marco Fumagalli L 596 H 434 P 220 mm	 <b>Esagono</b> design: Ronda Design Lab L 704 H 610 P 200 mm	 <b>Iron</b> design: Ronda Design Lab L 330 H 315 P 220 mm	 <b>Swing 01</b> design: Gino Carollo L 200 H 200 P 162 mm	 <b>Swing 02</b> design: Gino Carollo L 300 H 200 P 162 mm	 <b>Swing 03</b> design: Gino Carollo L 500 H 120 P 162 mm
 <b>Frame</b> design: Gino Carollo L 290/435/580 H 300 P 240 mm	 <b>Frame Light</b> design: Gino Carollo L 290/435/580 H 200 P 240 mm	 <b>Cart 01</b> design: Gino Carollo L 200 H 200 P 162 mm	 <b>Cart 02</b> design: Gino Carollo L 300 H 350 P 220 mm	 <b>Cart 03</b> design: Gino Carollo L 500 H 120 P 162 mm	 <b>Cart 04</b> design: Gino Carollo L 500 H 300 P 220 mm
 <b>Clip</b> design: Gino Carollo L 290/435/580 H 358 P 241 mm	 <b>Glax</b> design: Gino Carollo L 290 H 290 P 170 mm	 <b>Ellix</b> design: Gino Carollo L 200 H 200 P 210 mm	 <b>Ellix</b> design: Gino Carollo L 500 H 120 P 162 mm	 <b>Ellix</b> design: Gino Carollo L 200 H 200 P 210 mm	 <b>Ellix</b> design: Gino Carollo L 500 H 120 P 162 mm

## Appendiabiti Hangers

 <b>Volée</b> design: Gino Carollo L 96 H 293 P 59 mm	 <b>Bottone</b> design: Ronda Design Lab Ø 70 / 110 / 150 P 107 mm	 <b>Hat</b> design: Gino Carollo Ø 160 P 148 mm	 <b>Jazz</b> design: Studio 28 L 266 H 235 P 27 mm	 <b>Frame Coat</b> design: Gino Carollo L 290/435/580 H 300 P 240 mm	 <b>Tie</b> design: Gino Carollo L 435 H 90 P 65 mm
--	---	--	---	--	--

## Elementi speciali Special items

 <b>Esagono Panel</b> design: Ronda Design Lab L 704 H 610 P 20 mm	 <b>Mollotta</b> design: Ronda Design Lab L 42 H 219 P 60 mm	 <b>Caddy rain</b> design: Gino Carollo L 290 H 700 P 180 mm	 <b>Porta TV</b> L 322 H 275 P 28 mm	 <b>Porta TV</b> L 810 H 530 P 62 mm
--	--	--	---	--



## Specchi Mirrors

 <b>Snow</b> design: Gino Carollo Ø 400 / 500 / 1200 P 43/74 mm	 <b>Esagono Mirror</b> design: Ronda Design Lab L 704 H 610 P 24 mm	 <b>Jazz</b> design: Studio 28 L 600 H 900 P 40 mm
---	---	--

## Lampade Lamps

 <b>Lapilla</b> design: Debonademeo L 200 H 150 P 100 mm	 <b>Brand</b> design: Saverio Incombenti L 180 H 300 P 161 mm
---	---

## Fonoassorbente Soundproof

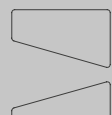
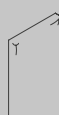
 <b>Paddle</b> design: Ronda Design Lab L 695 H 610 P 40 mm	 <b>Paddle</b> design: Studio 28 L 500 H 1200 P 40 mm	 <b>Paddle</b> design: Ronda Design Lab L 1000 H 684 P 40 mm	 <b>Paddle</b> design: Ronda Design Lab L 1000 H 580 P 40 mm	 <b>Bounce</b> design: Gino Carollo L 300/500/900 H 1200 P 65 mm
---	---	--	--	---

## Camera da letto Bedroom

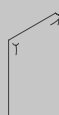





 <b>Bounce</b> design: Gino Carollo L 300/500/900 H 1200 P 65 mm
---

## Cucina Kitchen

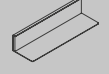
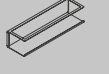
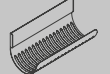
### Pryma Collection design: Studio 28

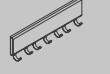
 <b>Porta mestoli</b> Ladle holder L 290 H 90 P 85 mm	 <b>Porta rotoli</b> Paper roll holder L 290 H 90 P 85 mm	 <b>Mensola</b> Shelf L 290 H 90 P 120 mm	 <b>Vaschetta piccola</b> Small bowl L 150 H 150 P 120 mm	 <b>Vaschetta grande</b> Big bowl L 290 H 90 P 120 mm
---	---	---	---	---

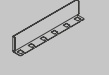
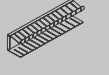
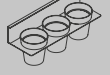
### Caren Collection design: Marco Fumagalli / Ronda Design Lab

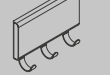
 <b>Mensola</b> Shelf L 298 H 73 P 104 mm	 <b>Porta barattoli</b> Jar holder L 298 H 80 P 104 mm	 <b>Porta rotoli</b> Paper roll holder L 298 H 162 P 168 mm	 <b>Barattolo</b> Jar L 116 H 106 P 115 mm	 <b>Gancio a fascia</b> Hook band L 298 H 93 P 27 mm	 <b>Porta tazze</b> Mug holder L 298 H 73 P 42 mm
 <b>Porta mestoli</b> Spoon rack L 298 H 73 P 42 mm	 <b>Porta coltelli</b> Knives rack L 298 H 80 P 77 mm	 <b>Porta vasi</b> Vases holder L 298 H 93 P 105 mm	 <b>Porta tablet</b> Tablet holder L 245 H 260 P 132 mm	 <b>Gancio</b> Hook L 40 H 93 P 27 mm	 <b>Gancio triplo</b> Triple hook L 128 H 93 P 27 mm

## Bagno Bathroom







### Bain Collection design: Studio 28

 <b>Porta asciugamani 01</b> Towel rail L 300 H 150 P 150 mm	 <b>Porta asciugamani 02</b> Towel rail L 500 H 150 P 150 mm	 <b>Porta asciugamani laterale</b> Side towel rail L 127 H 200 P 308 mm	 <b>Porta rotolo</b> Paper roll holder L 150 H 150 P 150 mm
--	--	---	---













### Bain Collection \_ Accessori opzionali \_ Optional accessories

 <b>Ripiano metallo</b> Metal shelf L 287/487 H 7 P 124 mm	 <b>Ripiano per accessori ceramica</b> Shelf for ceramic accessories L 287/487 H 7 P 124 mm	 <b>Vasetto ceramica</b> Ceramic pot L 80 H 96 P 80 mm	 <b>Portasapone ceramica</b> Ceramic soap dish L 136 H 20 P 100 mm	 <b>Portarotolo doppio</b> Double roll holder L 287 H 80 P 124 mm
--	---	--	--	--

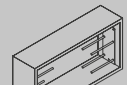
### Bain Collection \_ Esempi di composizioni \_ Composition examples

 01	 02	 03	 04	 05	 06
---	---	---	---	---	---

## Wine bar Collection

 <b>Box</b> design: Ronda Design Lab L 115 H 360 P 105 mm	 <b>Open Box</b> design: Ronda Design Lab L 105 H 360 P 105 mm	 <b>Double</b> design: Ronda Design Lab L 210 H 360 P 105 mm	 <b>Tris</b> design: Ronda Design Lab L 325 H 360 P 105 mm	 <b>Elle Bottle</b> design: Ronda Design Lab L 300 H 300 P 150 mm	 <b>Bet</b> design: Ronda Design Lab L 115 H 360 P 105mm	
 <b>Rettangolo Bottle</b> design: Ronda Design Lab L 600 H 300 P 150 mm	 <b>Spalla</b> design: Ronda Design Lab L 300 H 300 P 240 mm	 <b>Olo</b> design: Saverio Incombenti L 238 H 391 P 174 mm	 <b>Olo 2</b> design: Saverio Incombenti L 357 H 391 P 174 mm	 <b>H Wine glass</b> design: Ronda Design Lab L 300 H 300 P 220 mm	 <b>Blade Wine glass</b> design: Ronda Design Lab L 120 H 220 P 328 mm	 <b>Blade Shelf</b> design: Ronda Design Lab L 300 H 220 P 158 mm



**Basic** design: Ronda Design Lab

Pannello in ferro verniciato spessore 20 mm idoneo all'utilizzo di mensole ed accessori magnetici.  
20 mm thick painted metal panel suitable for magnetic shelves and accessories.

Dimensioni - Dimensions (mm)  
Spessore - Thickness 20 mm

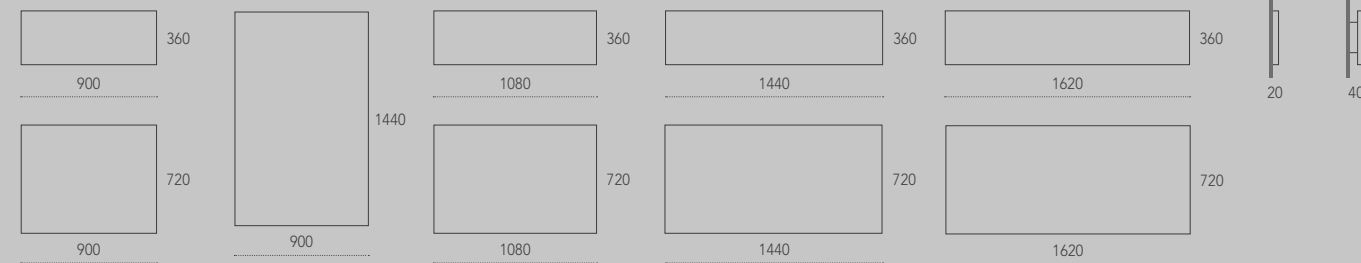

**Optional**  
Retroilluminazione led con distanziatori di 20 mm.  
Led backlighting with 20 mm thick spacers.

**Jazz** design: Studio 28

Pannello in metallo verniciato o impiallacciato con bordi a 45°.  
Painted or veneered metal panel with 45° edges.

Dimensioni - Dimensions (mm)  
Spessore - Thickness 31 mm

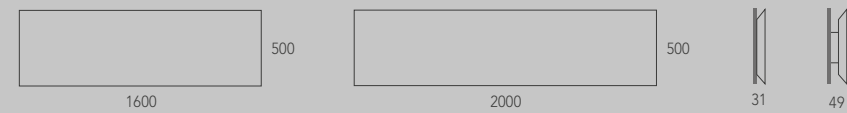

**Optional**  
Retroilluminazione led con distanziatori di 18 mm.  
Led backlighting with 18 mm thick spacers.

**Bench** design: Studio 28

Sistema magnetico porta TV composto da uno o due pannelli in metallo impiallacciato e da un piano d'appoggio in legno. Combinabile con tutte le mensole e accessori magnetici potenziati 2.0. Magnetic TV stand composed of one or two veneered metal panels and a wooden shelf. Combinable with all the 2.0 enhanced magnetic shelves and accessories.

Dimensioni - Dimensions (mm)  
Spessore - Thickness 20 mm

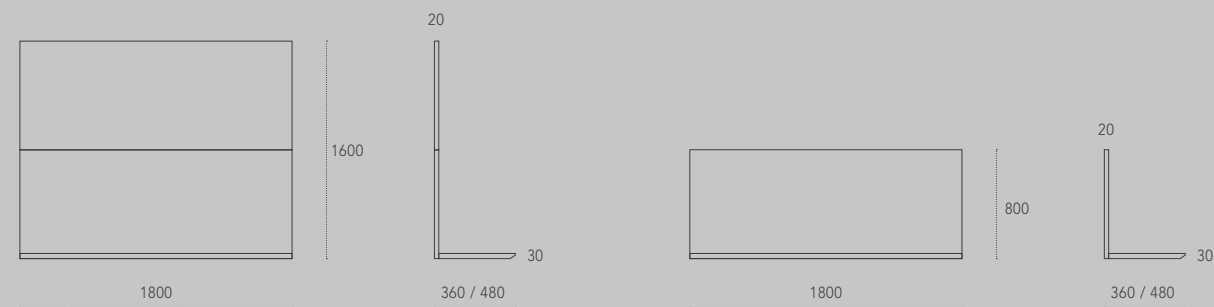

**Mr Hyde** design: Adriani e Rossi

Contenitore porta TV in vetro specchiato nero. All'accensione del televisore lo specchio lascia intravedere lo schermo TV. Televisore non in dotazione.  
Wall mounted TV storing cabinet with a black mirror door. Once turned on, the TV screen becomes visible through the glass door. Does not include television.

Dimensioni - Dimensions (mm)  
Profondità esterna - External depth 190 mm / Profondità interna - Internal depth 116 mm

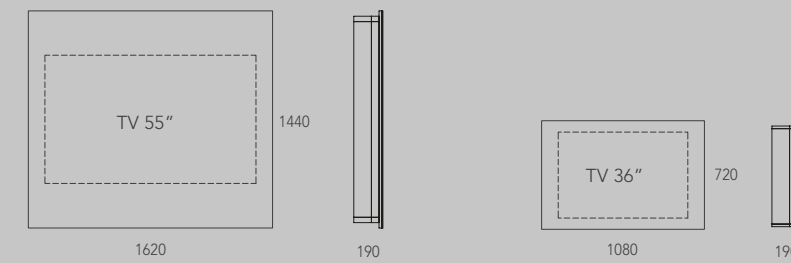

**Optional**  
Retroilluminazione led.  
Led backlighting.

**Iron** design: Ronda Design Lab

Base contenitore con cover in metallo. Anta in legno o rivestita in metallo.  
Deep drawer base with a metal cover. Veneered or metal covered front door.

Dimensioni - Dimensions (mm)  
Basi - Bases

Profondità - Depth 480 mm

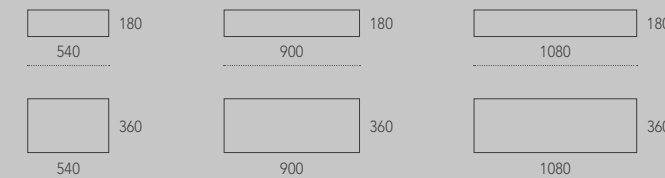

Dimensioni - Dimensions (mm)  
Pensili - Wall units

Profondità - Depth 360 mm

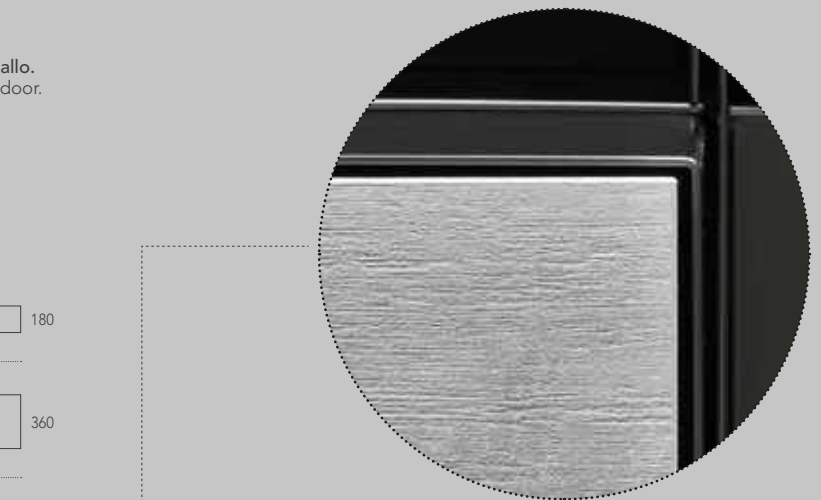
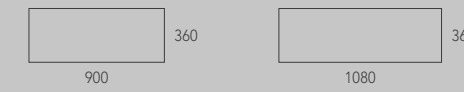

Cover in metallo piegato. Anta a filo.  
Folded metal cover. Recessed door.



# Indice dei complementi d'arredo / Furnishings index



Ki pag. 124



Ki XL pag. 130



Ki Round pag. 134



Mexa pag. 136



Slice pag. 140



Twirl pag. 144



Gemini pag. 146



Quasimodo pag. 150



Opera pag. 154



Panta Rei pag. 158



Asana pag. 162



Nirvana pag. 168



Mantra pag. 174



Izoard pag. 172



Otium pag. 180



Asana pag. 166



Nirvana pag. 170



Mantra pag. 176



Mantra pag. 178



Nemesi pag. 184



Doride pag. 186

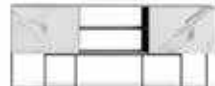

Bermuda pag. 188



Soho pag. 190



Bikram pag. 194



Levia Console pag. 196



Birdie pag. 85 - 208



Spot pag. 240



Levia TV pag. 198



Bench pag. 22 - 94



Mr Hyde pag. 26



Levia pag. 200



Polis pag. 208



Libera pag. 212



Iron-ic pag. 216



Su pag. 220



Wu Su Line pag. 222



Ago & Filo pag. 224



Prima pag. 226



Axis pag. 230



Atik pag. 232



Eureka pag. 234



Bogey pag. 92



Wink pag. 242



Ace pag. 236



Ark pag. 238



Snow pag. 48



Esagono pag. 36



Jazz pag. 86



Jazz pag. 86



Brassie pag. 246



Brassie Round pag. 250



Lift pag. 252



Chia pag. 254



Brand pag. 256



Lapilla pag. 258



Lift Floor pag. 260



Pivot pag. 262

Complementi d'arredo Furnishings



# Tavoli e sedie

Tables and chairs

**Tavoli** Tables

**Sedie** Chairs

**Sgabelli** Stools

**Poltroncine** Armchairs

**Pouf** Poufs







**Ki** design: Studio 28

Tavolo con base in metallo verniciato rame opaco e top sagomato in ceramica finitura Calacatta bianco.

Table with copper painted metal base and shaped top in Calacatta ceramics.

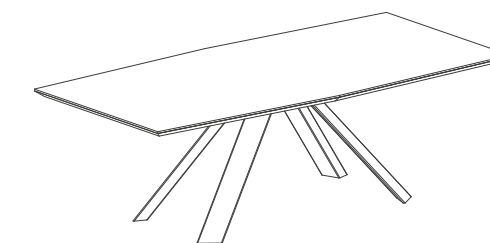

L 2400 H 745 P 1050 / 1150 mm



**Asana**  
Sedia imbottita. Padded chair.







**Ki** design: Studio 28

Tavolo con base e top sagomato in metallo finitura peltro.

Table with base and top in pewter painted metal.

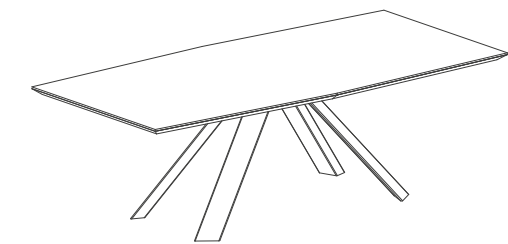

L 2400 H 745 P 1050 / 1150 mm



**Ki** design: Studio 28

Tavolo con base in metallo verniciato ottone opaco e top in noce Canaletto.

Table with brass painted metal base and American walnut top.

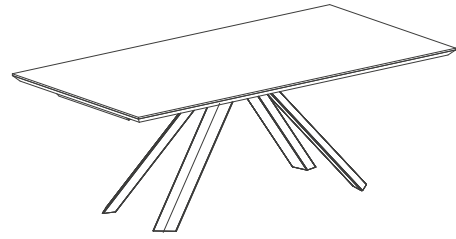

L 2400 H 745 P 1050 / 1150 mm



**Asana**

Poltroncina imbottita. Padded easy chair.









**Ki XL** design: Studio 28

Tavolo con base in metallo verniciato nero e top in frassino nero.

Table with black painted metal base and black ash top.

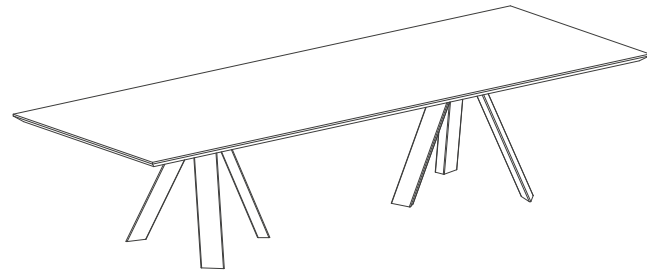

L 3400 H 745 P 1200 mm



**Asana**  
Poltroncina imbottita. Padded easy chair.







**Ki Round** design: Studio 28

**Foto a sinistra.**  
Tavolo con base in metallo verniciato grafite e top in frassino nero.

**Foto in basso.**  
Tavolo con base in metallo verniciato grafite e top in ceramica Étoile crema.

**Photo on the left.**  
Table with graphite painted metal base and black ash top.

**Photo below.**  
Table with graphite painted metal base and Étoile cream ceramic top.

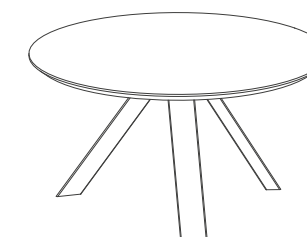

Ø 1400 H 745 mm



**Nirvana**  
Sedia imbottita. Padded chair.



**Mantra**  
Sedia imbottita. Padded chair.











**Mexa** design: Studio 28

**Foto a sinistra.**  
Tavolo con base in metallo verniciato bronzo e top sagomato in ceramica Calacatta.  
**Foto in basso.**  
Dettaglio base in rame brunito.

**Photo on the left.**  
Table with bronze painted metal base and shaped top in Calacatta ceramics.  
**Photo below.**  
Aged copper base detail.

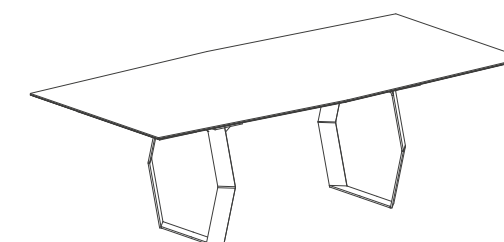

L 2400 H 745 P 1050 / 1150 mm



**Brassie 5**  
Lampadario. Chandelier.



**Mantra**  
Sedia imbottita. Padded chair.





**Slice** design: Studio 28

Tavolo con base in metallo verniciato bronzo e top sagomato in ceramica Thurdernight.

Table with bronze painted metal base and shaped top in Thurdernight ceramics.

L 2400 H 1100 P 745 mm







**Slice** design: Studio 28

Tavolo con base in metallo verniciato titanio e top sagomato in ceramica Statuario. Dettaglio in basso con base in finitura grafite.

Table with titanium painted metal base and shaped top in Statuario ceramics. Picture below in graphite finish.

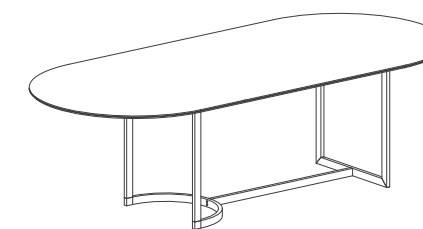

L 2400 H 745 P 1100 mm

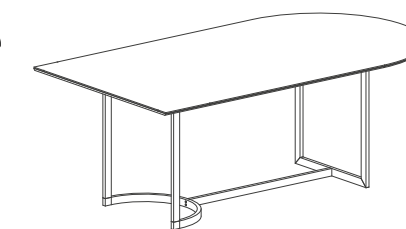

L 2000 H 745 P 1100 mm



**Lift**  
Lampada a sospensione. Suspended lamp.



**Asana**  
Sedia imbottita. Padded chair.





**Twirl** design: Studio 28

Tavolo con base in metallo verniciato nero e top in ceramica nero Marquinia.

Table with black painted metal base and top in black Marquinia ceramics.

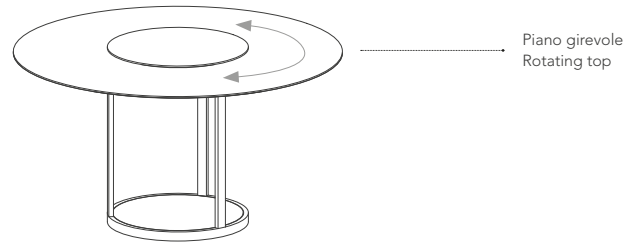

Ø 1400 H 753 mm



**Izoard**  
Sedia imbottita. Padded chair.











**Gemini** design: Studio 28

Tavolo con base in metallo verniciato ottone opaco e top in ceramica Statuario.

Table with matt brass painted metal base and top in Statuario ceramics.

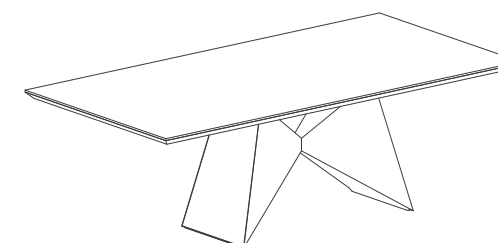

L 2000 H 745 P 1000 mm



**Nirvana**  
Sedia imbottita. Padded chair.











**Quasimodo** design: Adriani e Rossi

Tavolo con base in metallo verniciato grafite e top sagomato in finitura Étoile crema.

Table with graphite painted metal base and shaped top in Étoile cream ceramics.

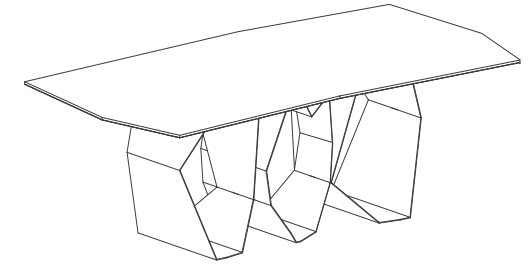

L 2200 H 760 P 1200 mm

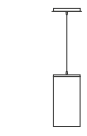

**Brassie**  
Lampada a sospensione. Suspended lamp.



**Izoard**  
Sedia imbottita. Padded chair.

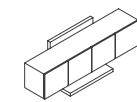

**Soho**  
Madia. Sideboard.









**Opera** design: Studio 28

Tavolo con base in metallo verniciato bronzo e top sagomato in finitura ceramica Statuario.

Table with bronze painted metal base and shaped top in Statuario ceramics.

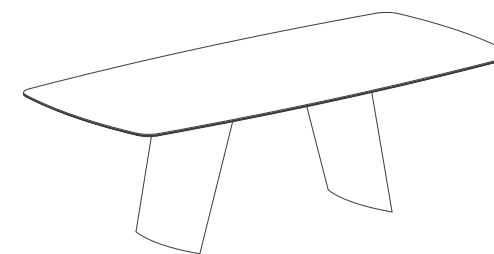

L 2400 H 745 P 1050 / 1150 mm



**Brassie 4**  
Lampadario. Chandelier.



**Asana**  
Sedia imbottita. Padded chair.



**Levia**  
Libreria in metallo. Metal bookcase.











**Pantà Rei** design: Studio 28

Tavolo allungabile con base in metallo verniciato titanio e top in noce Canaletto. Dettaglio in basso con base in finitura nero.

Extendable table with titanium painted metal base and American walnut top. Black finished base in picture below.

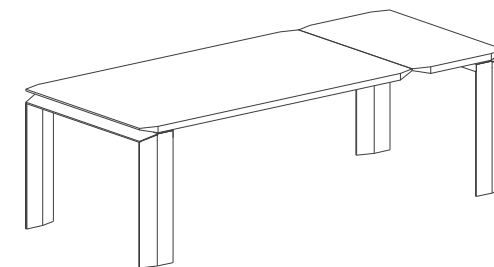

L 1800 / 2400 H 745 P 1000 mm





**Asana** design: Studio 28

**Foto in basso.**  
Sedia con struttura in metallo verniciato titanio  
e seduta imbottita con rivestimento in velluto mattone.

**Foto a destra.**  
Sedia con struttura in metallo verniciato nero  
e seduta imbottita con rivestimento in pelle nero.

**Photo below.**  
Chair with titanium painted metal structure  
and upholstered seat in brick color velvet.

**Photo on the right.**  
Chair with black painted metal structure  
and upholstered seat in black leather.



L 510 H, 460 H<sub>2</sub> 760 P 580 mm

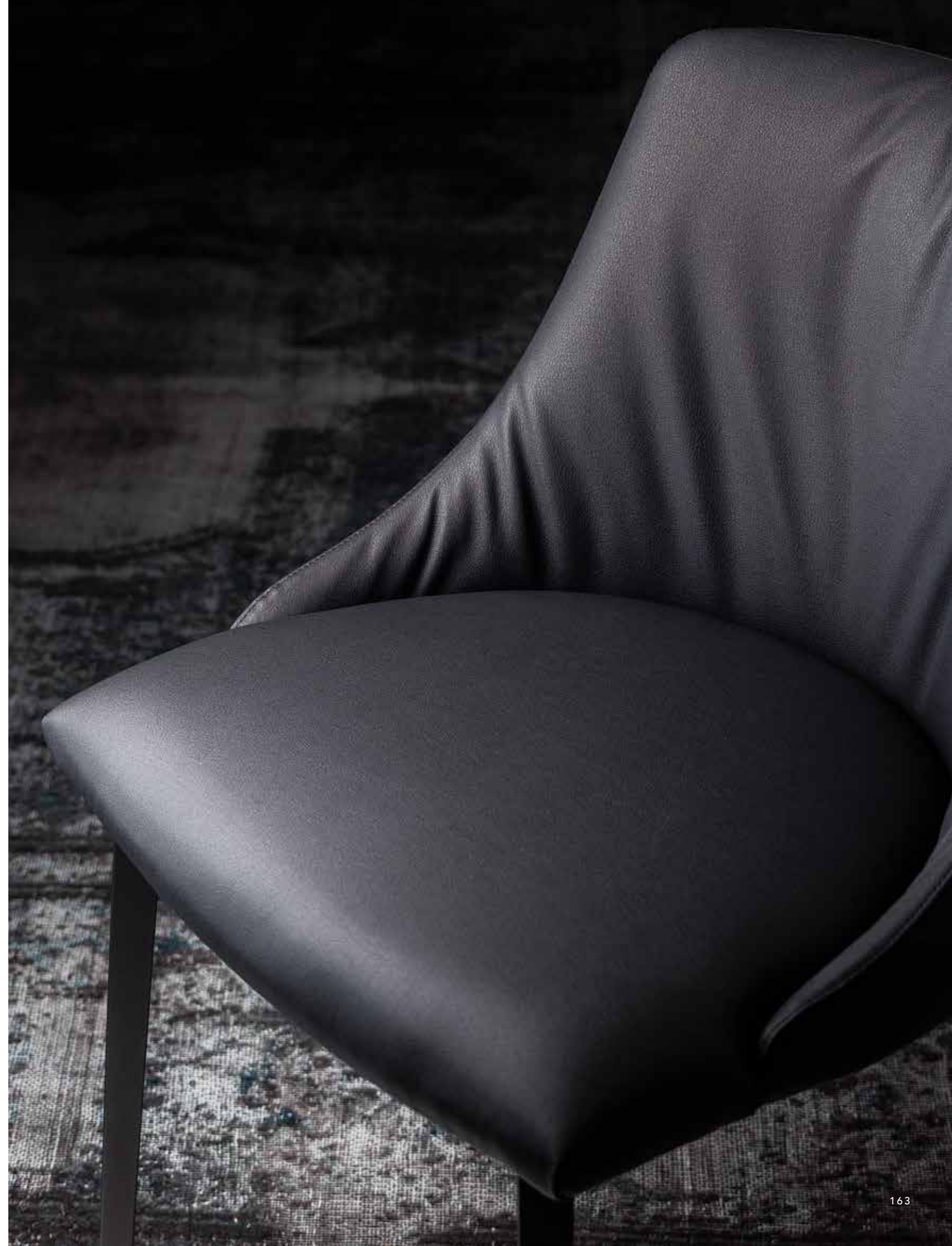





**Asana** design: Studio 28

Poltroncina con struttura in metallo verniciato nero e seduta imbottita con rivestimento in pelle giallo.

Easy chair with black painted metal structure and upholstered seat in yellow leather.



L 550 H, 460 H<sub>2</sub> 760 P 600 mm







**Asana** design: Studio 28

Sgabello con struttura in metallo verniciato titanio e seduta imbottita con rivestimento in velluto ocra.

Stool with titanium painted metal structure and upholstered seat in ochre color velvet.



L 510 H, 670 H<sub>2</sub> 850 P 520 mm



L 510 H, 770 H<sub>2</sub> 950 P 520 mm







**Nirvana** design: Studio 28

**Foto a sinistra.**

Sedia con schienale basso, struttura in metallo verniciato nero e seduta imbottita con rivestimento in velluto verde bosco.

**Foto in basso.**

Sedia con schienale basso, struttura in metallo verniciato ottone opaco e seduta imbottita con rivestimento in velluto mattone.

Sedia con schienale alto, struttura in metallo verniciato grafite e seduta imbottita con rivestimento in velluto ottanio.

**Photo on the left.**

Chair with low back, black painted metal structure and upholstered seat in forest green velvet.

**Photo below.**

Chair with low back, matt brass painted metal structure and upholstered seat in brick color velvet.

Chair with high back, graphite painted metal structure and upholstered seat in teal color velvet.



L 470 H<sub>1</sub> 470 H<sub>2</sub> 780 P 530 mm



L 470 H<sub>1</sub> 470 H<sub>2</sub> 870 P 550 mm







**Nirvana** design: Studio 28

**Foto a sinistra.**  
Sgabello con struttura in metallo grafite e seduta imbottita con rivestimento in velluto carminio e grigio.

**Foto in basso.**  
Sgabello basso con struttura in metallo nero e seduta imbottita con rivestimento in pelle sabbia.  
Sgabello alto con struttura in metallo nero e seduta imbottita con rivestimento in pelle nera.

**Photo on the left.**  
Stool with graphite painted metal structure and upholstered seat in carmine and grey velvet.

**Photo below.**  
Low stool with black painted metal structure and upholstered seat in sand leather.  
High stool with black painted metal structure and upholstered seat in black leather.



L 470 H<sub>1</sub> 660 H<sub>2</sub> 890 P 480 mm



L 470 H<sub>1</sub> 760 H<sub>2</sub> 990 P 480 mm





**Izoard** design: Adriani e Rossi

Sedia con struttura in metallo verniciato grafite e seduta imbottita con rivestimento in pelle sabbia.

Chair with graphite painted metal structure and upholstered seat in sand leather.



L 550 H, 470 H<sub>2</sub>, 750 P 570 mm

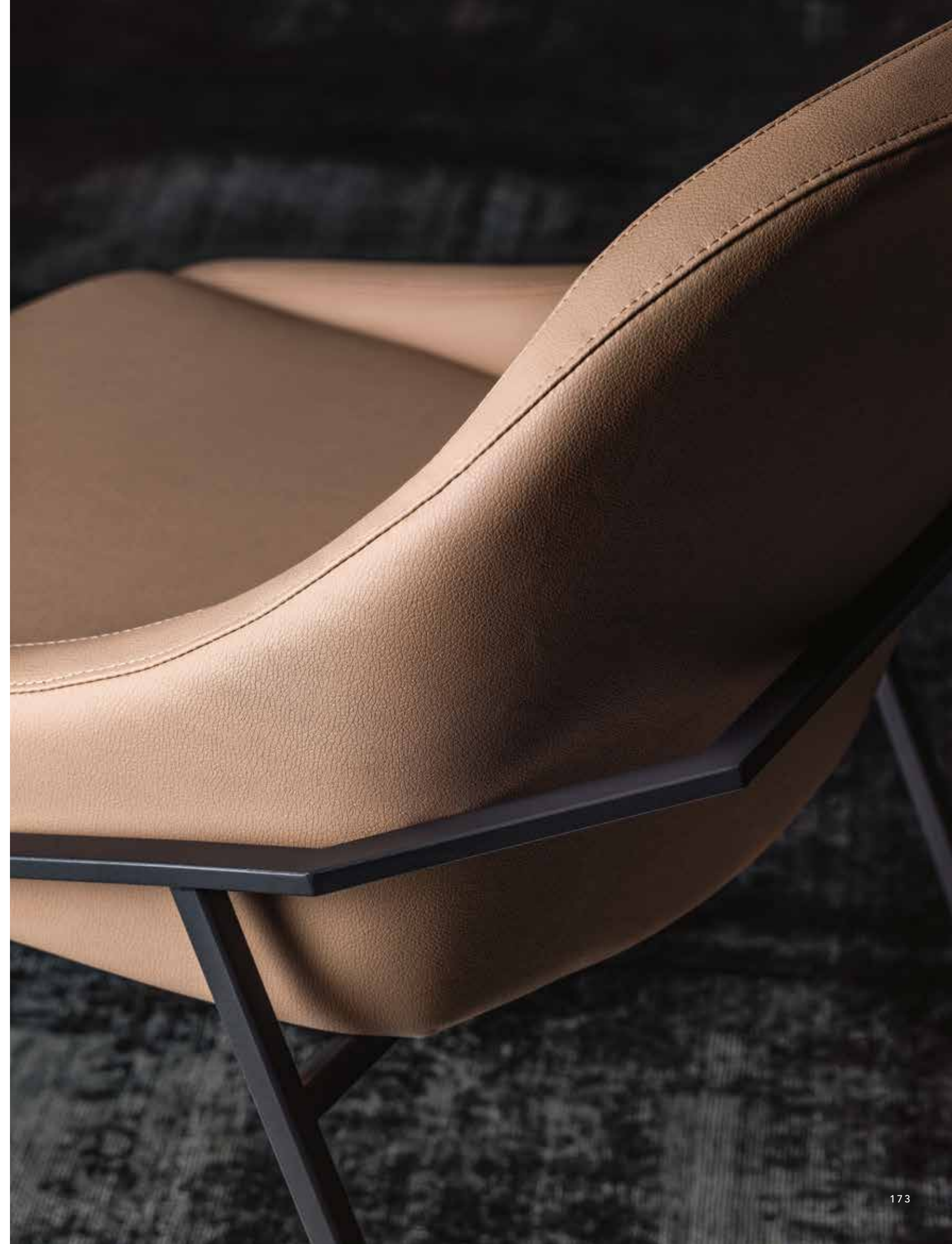





**Mantra** design: Gino Carollo

Sedia con struttura in metallo verniciato bronzo e seduta imbottita in velluto blu di Prussia.

Chair with bronze painted metal structure and upholstered seat in Prussian blue velvet.



L 600 H<sub>1</sub> 420 H<sub>2</sub> 820 P 570 mm







**Mantra** design: Gino Carollo

Sgabello con struttura in metallo verniciato titanio e seduta imbottita con rivestimento in velluto mattone.

Stool with titanium painted metal structure and upholstered seat in brick color velvet.



L 490 H, 785 H<sub>2</sub> 1090 P 510 mm





**Mantra** design: Gino Carollo

Poltrona con struttura in metallo verniciato grafite, seduta imbottita con rivestimento in velluto verde bosco. Pouf abbinato nelle stesse finiture.

Armchair with graphite painted metal structure and upholstered seat in forest green velvet. Pouf in matching colours.

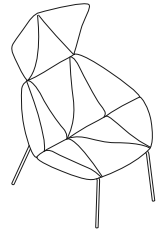

L 918 H 1175 P 830 mm

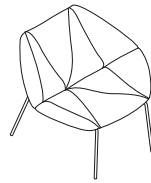

L 918 H 890 P 830 mm



L 680 H 390 P 635 mm





**Otium** design: Studio 28

**Foto in basso.**

Pouf con struttura in metallo verniciato nero e seduta imbottita con rivestimento in velluto verde acido.

**Foto a destra.**

Pouf con struttura in metallo verniciato grafite e seduta imbottita con rivestimento in velluto sabbia.  
Pouf con struttura in metallo verniciato grafite e seduta imbottita con rivestimento in velluto verde bosco.

**Photo below.**

Pouf with black painted metal structure and upholstered seat in acid green velvet.

**Photo on the right.**

Pouf with graphite painted metal structure and upholstered seat in sand velvet.  
Pouf with graphite painted metal structure and upholstered seat in forest green velvet.

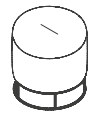

Ø 420 H 460 mm

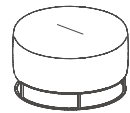

Ø 700 H 460 mm





Complementi d'arredo Furnishings



# Madie e librerie

Sideboards and bookcases

**Madie** Sideboards

**Consolle** Consoles

**Porta TV** TV stands

**Librerie** Bookcases

**Vetrinette** Display cabinets





**Nemesi** design: Gino Carollo

Madia rivestita in metallo verniciato bronzo.

Metal covered sideboard, bronze finish.

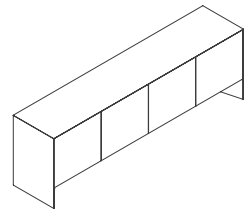

L 2206 H 704 P 472 mm

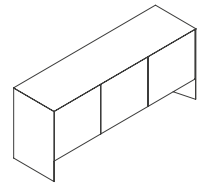

L 1656 H 704 P 472 mm







**Doride** design: Studio 28

**Foto a sinistra.**  
Madia con piedini in metallo verniciato rame opaco e corpo in frassino nero.

**Foto in basso.**  
Madia con piedini in metallo verniciato ottone opaco e corpo in noce Canaletto.

**Photo on the left.**  
Sideboard with feet in matt copper painted metal and body in black ash.

**Photo below.**  
Sideboard with feet in matt brass painted metal and body in American walnut.

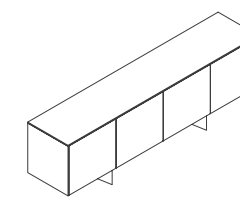

L 2220 H 702 P 470 mm

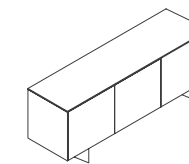

L 1656 H 702 P 470 mm



**Jazz**  
Specchio. Mirror.





**Bermuda** design: Gino Carollo

**Foto in basso.**  
Madia in metallo verniciato titanio e ceramica Statuario.

**Foto a destra.**  
Madia in metallo verniciato grafite e ceramica Statuario.

**Photo below.**  
Metal and ceramics sideboard. Finishes: titanium and Statuario.

**Photo on the right.**  
Metal and ceramics sideboard. Finishes: graphite and Statuario.

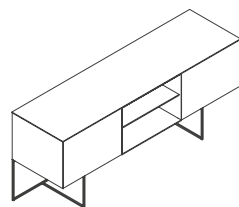

L 1800 H 754 P 500 mm



**Snow**  
Specchio magnetico. Magnetic mirror.









**Soho** design: Ronda Design Lab

Madia rivestita in metallo verniciato peltro.  
Supporto in legno laccato nero.

Metal covered sideboard, pewter finish.  
Support in black lacquered wood.

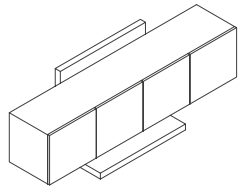

L 2205 H 860 P 530 mm







**Bikram** design: Gino Carollo

Madia componibile in legno e metallo. Finiture: bronzo e nero.

Modular metal and wooden sideboard, bronze and black finish.

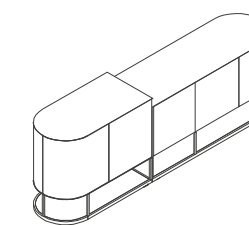

L 2500 H 850 P 520 mm

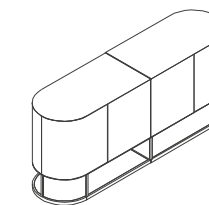

L 2000 H 850 P 520 mm

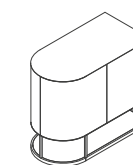

L 1000 H 850 P 520 mm

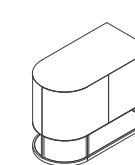

L 1000 H 750 P 520 mm

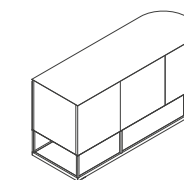

L 1500 H 750 P 520 mm



**Snow**  
Specchio magnetico. Magnetic mirror.







**Levia Console** design: Gino Carollo

Consolle in metallo verniciato grafite.

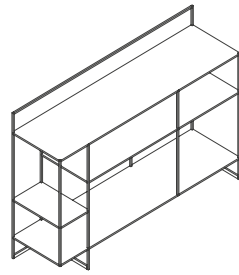
Painted metal console, graphite finish.



L 1200 H 808 P 320 mm

 **Snow**  
Specchio magnetico. Magnetic mirror.

 **Brand**  
Lampada magnetica. Magnetic lamp.







**Levia TV** design: Gino Carollo

Porta tv in metallo verniciato tortora.

Painted metal tv stand, taupe finish.

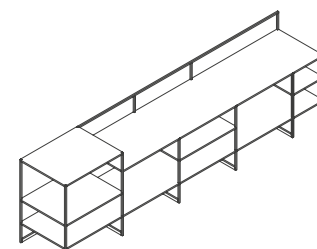

L 1800 H 500 P 320 mm



**Brand**  
Lampada magnetica. Magnetic lamp.



**Cart**  
Mensola magnetica. Magnetic shelf.



**Levia**  
Libreria in metallo. Metal bookcase.





**Levia** design: Gino Carollo

Libreria in metallo verniciato grafite.

Painted metal bookcase, graphite finish.

L 3600 H 2500 P 320 mm







**Levia** design: Gino Carollo

Libreria in metallo verniciato nero.

Painted metal bookcase, black finish.

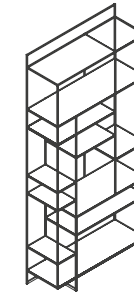

L 900 H 2000 P 320 mm





**Levia Air** design: Gino Carollo

Libreria sospesa in metallo verniciato grafite.

Suspended metal bookcase, graphite finish.

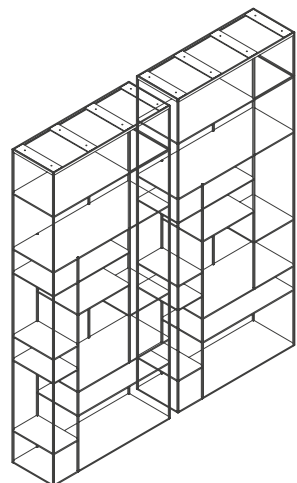

L 1820 H 2076 P 320 mm





**Levia** design: Gino Carollo

Libreria in metallo verniciato ottone con ripiani in ceramica Étoile crema.  
Dettaglio in basso in finitura rame.

Metal bookcase in brass finish with Étoile cream ceramic ledges.  
Picture below in copper finish.

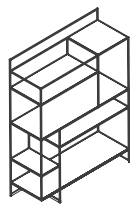

L 900 H 1200 P 320 mm



 **Cart**  
Mensola magnetica. Magnetic shelf.

 **Swing**  
Vaschetta magnetica. Magnetic container.







**Polis** design: Gino Carollo

Libreria componibile in metallo verniciato in finitura tortora.

Modular bookcase in taupe finished painted metal.

L 3200 H 3200 P 300 mm





**Polis** design: Gino Carollo

**Foto a sinistra.**  
Libreria componibile in metallo verniciato tortora.

**Foto in basso.**  
Libreria componibile in metallo verniciato nero.

**Photo on the left.**  
Modular bookcase, taupe finish.

**Photo below.**  
Modular metal bookcase, black finish.

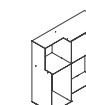
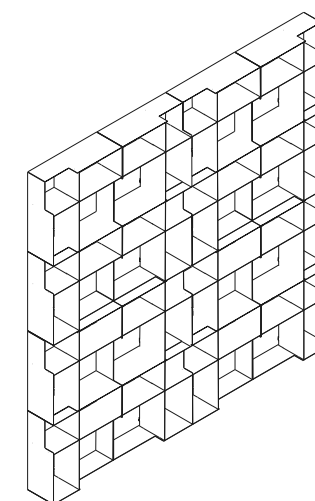

Modulo destro. Right module.  
L 800 H 800 P 300 mm

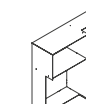

Modulo sinistro. Left module.  
L 800 H 800 P 300 mm

L 3200 H 3200 P 300 mm

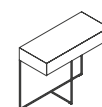

**Birdie**  
Consolle magnetica.  
Magnetic console.





**Libera 45** design: Gino Carollo

Libreria componibile magnetica in noce Canaletto e metallo verniciato ottone opaco.

Modular magnetic bookcase in American walnut and matt brass painted metal.

L 4000 H 1145 P 420 mm





**Libera 45** design: Gino Carollo

**Foto in basso.**  
Libreria componibile magnetica in metallo verniciato rame opaco.

**Foto a destra.**  
Libreria componibile magnetica in noce Canaletto e metallo verniciato titanio.

**Photo below.**  
Modular magnetic bookcase in matt copper painted metal.

**Photo on the right**  
Modular magnetic bookcase in American walnut and titanium painted metal.

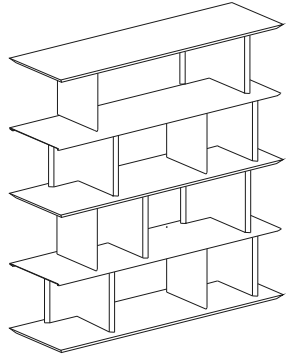

L 2000 H 1530 P 420 mm

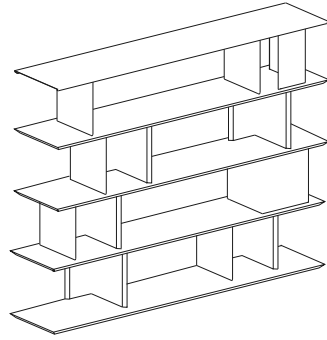

L 1600 H 1480 P 420 mm





**Iron-ic** design: Ronda Design Lab

**Foto a sinistra.**  
Libreria componibile in ferro naturale.

**Foto in basso.**  
Libreria componibile in metallo verniciato finitura nero e ottone.

**Photo on the left.**  
Modular metal bookcase in natural iron finish.

**Photo below.**  
Modular metal bookcase, black and brass finishes.



L 724 H 2160 P 300 mm

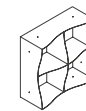

**Iron-ic**  
Modulo standard. Standard module.



**Iron-ic**  
Griglia portabottiglie. Bottle holder grid.



**Iron-ic**  
Croce portabottiglie. Bottle holder cross.







**Iron-ic** design: Ronda Design Lab

**Foto a sinistra.**  
Libreria componibile in metallo verniciato titanio. Moduli con ante in vetro fumè.

**Foto in basso.**  
Libreria componibile in metallo verniciato grafite. Moduli con ante in finitura cemento.

**Photo on the left.**  
Modular metal bookcase, titanium finish. Display cabinet modules with smoked glass doors.

**Photo below.**  
Modular metal bookcase, graphite finish. Modules with doors in concrete finish.

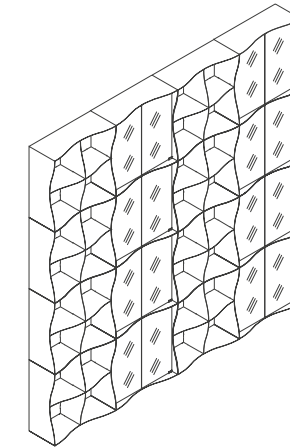

L 2880 H 2880 P 300 mm

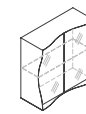

**Iron-ic Glass**  
Modulo vetrina. Display cabinet

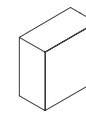

**Iron-ic Shelter**  
Modulo con ante. Module with door.

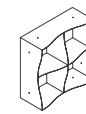

**Iron-ic**  
Modulo standard. Standard module.







**Su** design: Diego Collareda Etimodesign

**Foto a sinistra.**  
Libreria free-standing in metallo verniciato tortora.

**Foto in basso.**  
Libreria free-standing in ferro naturale e in metallo verniciato bianco.

**Photo on the left.**  
Free-standing bookcase in taupe painted metal.

**Photos below.**  
Free-standing bookcase in natural iron and white painted metal.



L 400 H 2005 P 400 mm



**Otium**  
Pouf con struttura in metallo. Pouf with metal structure.







**W Su Line** design: Diego Collareda Etimodesign

Libreria a parete in ferro naturale.

Wall-mounted bookcase in natural iron.

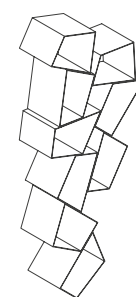

Montaggio verticale. Vertical mounting.  
L 720 H 1800 P 250 mm

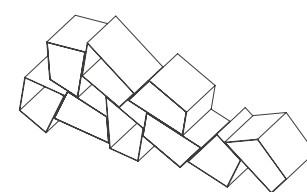

Montaggio orizzontale. Horizontal mounting.  
L 1800 H 720 P 250 mm







**Ago & Filo** design: Ronda Design Lab

Mensola in noce Canaletto con inserti in metallo verniciato bronzo.

American walnut shelf with bronze painted metal elements.

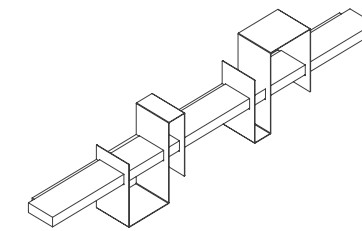

L 2100 H 452 P 253 mm





**Prima** design: Studio 28

Vetrina in cristallo extrachiaro. Ripiano inferiore con piastra led integrata.

Display cabinet in extra-clear glass. Integrated bottom led lighting plate.

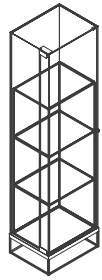

L 486 H 1856 P 382 mm



**Glax**  
Mensola magnetica in vetro.  
Glass magnetic shelf.





Complementi d'arredo Furnishings



# Complementi

Furnishing accessories

Tavolini Coffee tables

Comodini Bedside tables

Specchi Mirrors

Carrelli porta vivande Food trolleys

Fioriere Planters





**Axis** design: Gino Carollo

**Foto in basso.**  
Tavolini in metallo verniciato titanio con top in ceramica Étoile crema.

**Foto a destra.**  
Tavolini in metallo verniciato nero con top in ceramica Étoile crema, noce Canaletto e metallo verniciato nero.

**Photo below.**  
Metal coffee tables with ceramic top. Titanium and Étoile cream finishes.

**Photo on the right**  
Metal coffee tables with ceramic and wooden top. Finishes: black, Étoile cream and American walnut.

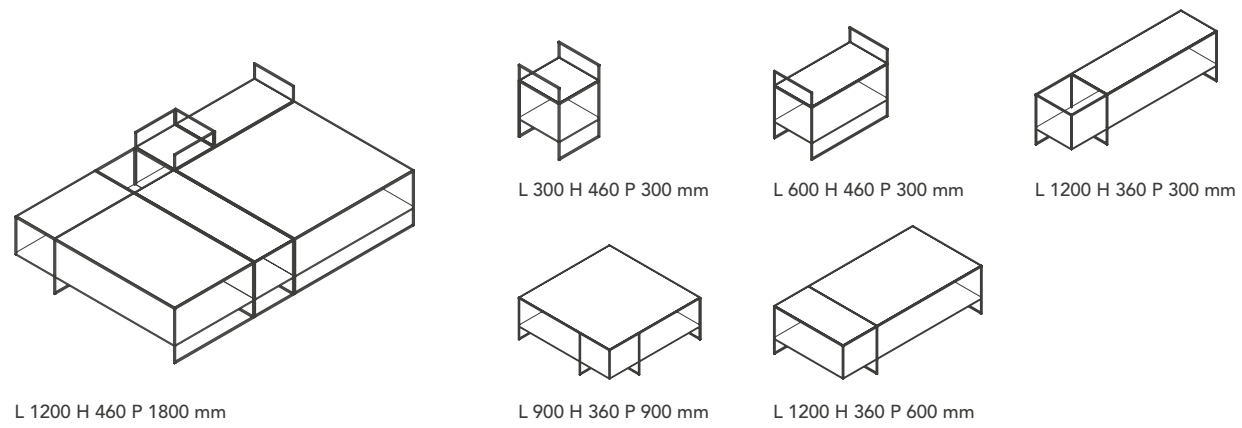





**Atik** design: Gino Carollo

**Foto a sinistra.**  
Comodino con cassetto in metallo verniciato verde.

**Foto in basso.**  
Tavolini in metallo verniciato ottone e nero.

**Photo on the left.**  
Painted metal bedside table with drawer, green finish.

**Photo below.**  
Painted metal coffee tables, brass and black finishes.

Atik small



L 350 H 600 P 300 mm

Atik medium  
Destro \_ Right



Con cassetto \_ With drawer  
L 400 H 600 P 350 mm

Atik medium  
Sinistro \_ Left

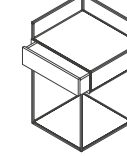





**Eureka** design: Studio 28

Tavolino in noce Canaletto e metallo verniciato nelle finiture titanio, nero e ottone.

Painted metal coffee tables with American walnut top. Titanium, black and brass finishes.

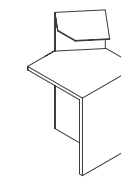

L 400 H 605 P 400 mm







**Ace** design Luca Roccadadria

**Foto a sinistra.**  
Specchi con cornice in metallo verniciato rame brunito.

**Foto in basso.**  
Specchio con cornice in metallo verniciato bronzo.

**Photo on the left.**  
Mirrors with aged copper painted metal frames.

**Photo below.**  
Mirror with bronze painted metal frame.

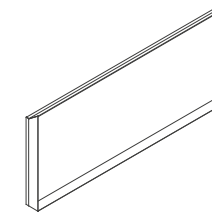

L 1705 H 730 P 75 mm

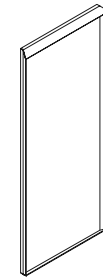

L 730 H 1705 P 75 mm







**Ark** design: Studio 28

Set di specchi con cornice in metallo verniciato rame brunito.

Mirror set with painted metal frame, aged copper finish.

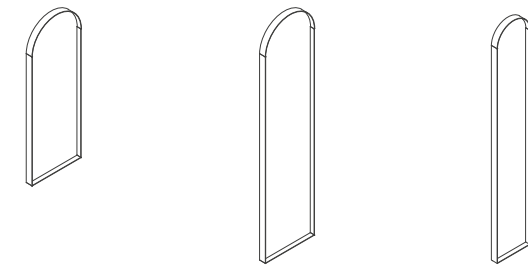

L 435 H 1200 P 60 mm

L 435 H 1800 P 60 mm

L 290 H 1800 P 60 mm



**Otium**  
Pouf con struttura in metallo.  
Pouf with metal structure.



**Bottone**  
Appendiabiti magnetico.  
Magnetic hanger.





**Spot** design: Studio 28

**Foto in basso.**  
Carrello portavivande in metallo verniciato titanio con ripiano in ceramica Statuario.  
Accessori magnetici della collezione Caren.

**Foto a destra.**  
Carrello portavivande in metallo verniciato tortora con ripiano in ceramica Étoile crema.

**Photo below.**  
Painted metal food trolley in titanium finish with Statuario ceramic top.  
Caren collection magnetic accessories.

**Photo on the right**  
Painted metal food trolley in taupe finish with Étoile cream ceramics top.

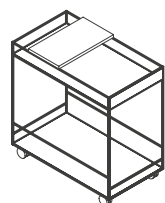

L 800 H 830 P 450 mm







**Wink** design: Gino Carollo

Set di fioriere in metallo verniciato nero e bronzo.

Set of painted metal planters. Black and bronze finishes.



L 260 H 340 P 260 mm

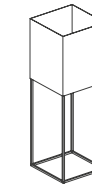

L 260 H 790 P 260 mm

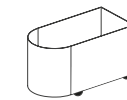

L 520 H 280 P 260 mm

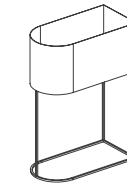

L 520 H 720 P 260 mm





Complementi d'arredo Furnishings



---

# Lampade

Lamps

---

Lampade a sospensione Suspended lamps

Lampade da tavolo Table lamps

Lampade magnetiche Magnetic lamps

Lampade da terra Floor lamps





**Brassie** design: Gino Carollo

Lampadario in metallo verniciato bronzo con illuminazione a piastre led.

Painted metal chandelier, bronze finish. Led panel lighting.

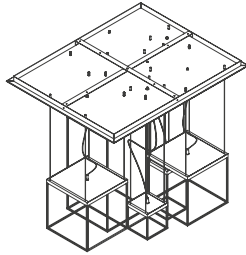

**Brassie 5**

L 1000 P 800 mm

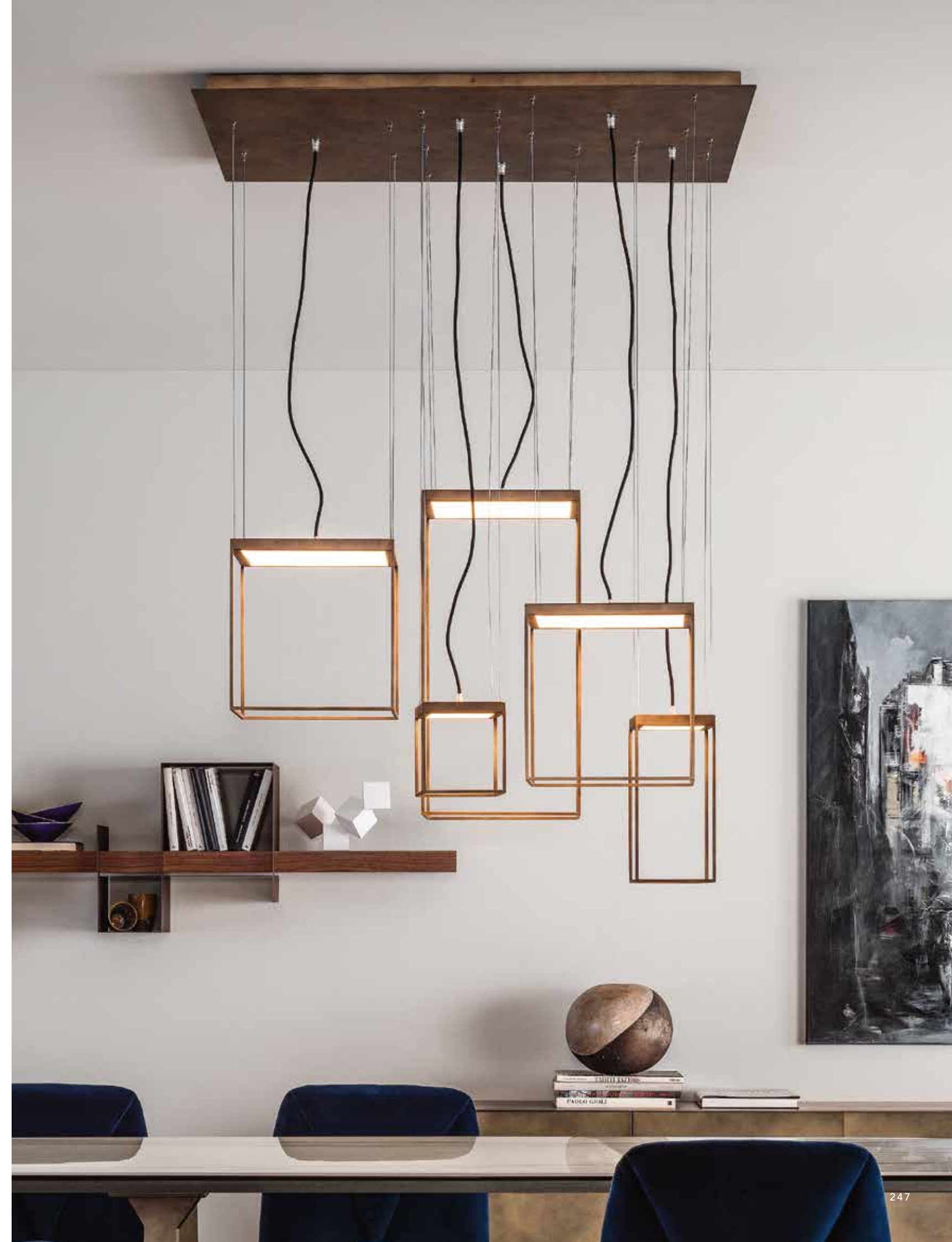



**Brassie** design: Gino Carollo

Lampade a sospensione e lampadario in metallo verniciato nero con illuminazione a piastre led.

Painted metal suspended lamps and chandelier, black finish. Led panel lighting.

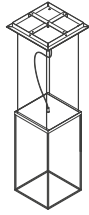

**Brassie D**

L 300 H 600 P 300 mm

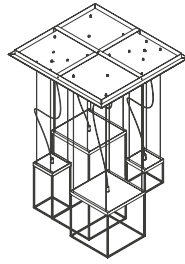

**Brassie 4**

L 700 P 750 mm





**Brassie Round** design: Gino Carollo

Lampade a sospensione in metallo verniciato titanio e rame con illuminazione a piastre led.

Painted metal suspended lamps, titanium and copper finishes. Led panel lighting.

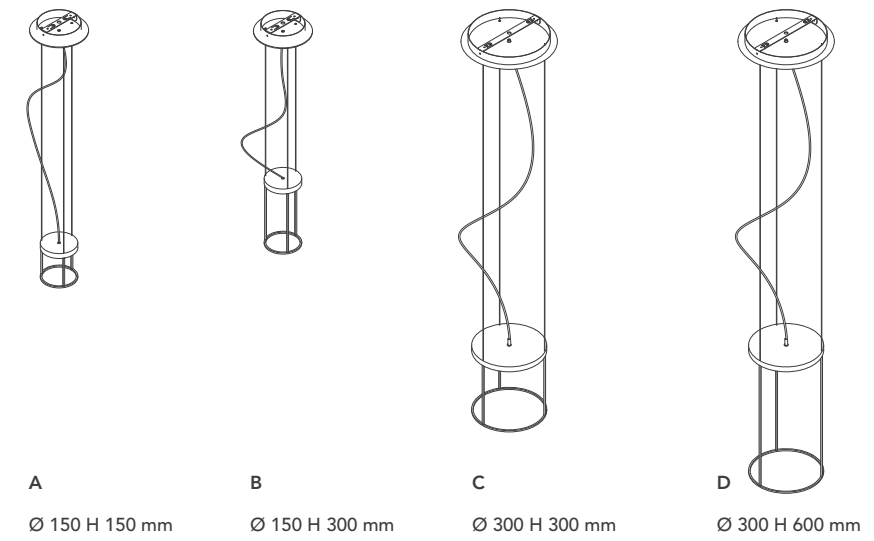



**Lift** design: Studio 28

Lampade a sospensione in metallo verniciato grafite e nero con piastra led circolare orientabile.

Painted metal suspended lamps with adjustable led plate. Graphite and black finishes.



L 350 H 700 P 20 mm







**Chia** design: Gino Carollo

Lampada led ricaricabile da tavolo in metallo verniciato titanio.

Rechargeable painted metal table lamp with led technology. Titanium finish.

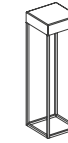

L 110 H 368 P 110 mm



Ricaricabile  
Rechargeable



Carica batteria  
Battery charger



Autonomia 15 ore  
Runtime 15 hours



4 intensità di luce  
4 light intensity



Luce calda  
Warm light



Made in Italy



Certificato europeo  
European certificate



IP33







**Brand** design: Saverio Incombenti

Lampada magnetica ricaricabile in metallo verniciato nero.

Rechargeable magnetic lamp with led technology. Black painted metal.

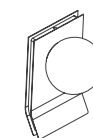

L 180 H 300 P 161 mm



**Glax**  
Mensola magnetica in vetro.  
Glass magnetic shelf.



Ricaricabile  
Rechargeable



Carica batteria  
Battery charger



Autonomia 15 ore  
Runtime 15 hours



4 intensità di luce  
4 light intensity



Luce calda  
Warm light



Made in Italy



Certificato europeo  
European certificate



Lampada magnetica  
Magnetic lamp





**Lapilla** design: Debonademeo

Lampada magnetica a led in metallo verniciato nero.  
Disponibile con filo o ricaricabile.

Led magnetic lamp in black painted metal.  
Available with wire or rechargeable.

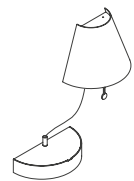

Paralume \_ Lampshade  
L 200 H 150 P 100 mm

Base \_ Base  
L 200 H 40 P 100 mm







**Lift Floor** design: Studio 28

Lampada da terra in metallo verniciato nero con piastra led orientabile.

Painted metal floor lamp with adjustable led plate, black finish.



L 350 H 2040 P 350 mm





**Pivot** design: Studio 28

**Foto in basso.**  
Lampada da terra in metallo verniciato grafite e top in ceramica.  
Illuminazione a piastra led.

**Foto a destra.**  
Lampade da terra in metallo verniciato peltro con piastra led.

**Photo below.**  
Painted metal floor lamp with led plate.  
Graphite finish with ceramic top.

**Photo on the right.**  
Painted metal floor lamps with led plate. Pewter finish.

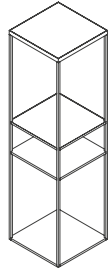

L 302 H 1110 P 302 mm





# Schede tecniche

Complementi d'arredo Furnishings

Technical sheet

Tavoli \_ Tables



**Ki** design: Studio 28

Struttura in metallo verniciato. Piano in legno, vetro, metallo o ceramica disponibile in formato rettangolare o sagomato.  
Painted metal base. Wooden, glass, metal or ceramic top, available in two versions: rectangular or shaped.

Dimensioni - Dimensions (mm)

**Piano rettangolare - Rectangular top**

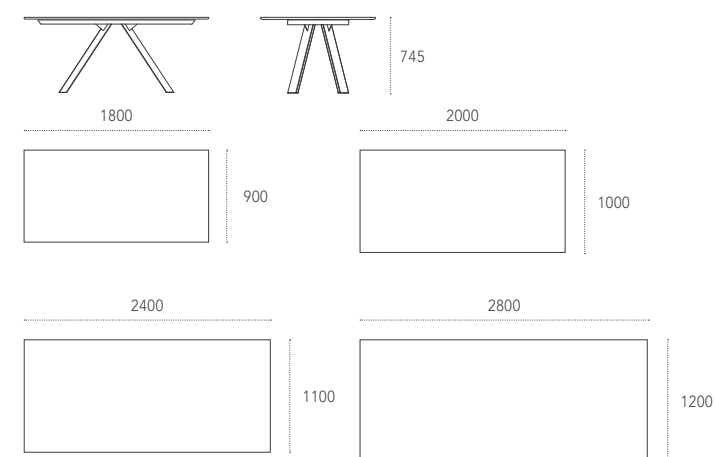

**Piano sagomato - Shaped top**

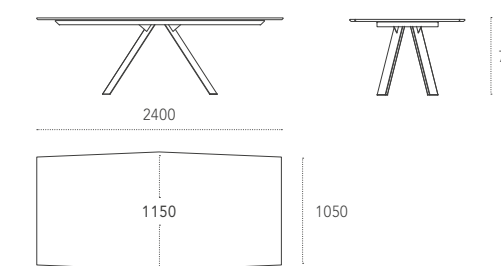

**Ki XL** design: Studio 28

Struttura in metallo verniciato e piano in legno.  
Painted metal base and wooden top.

Dimensioni - Dimensions (mm)

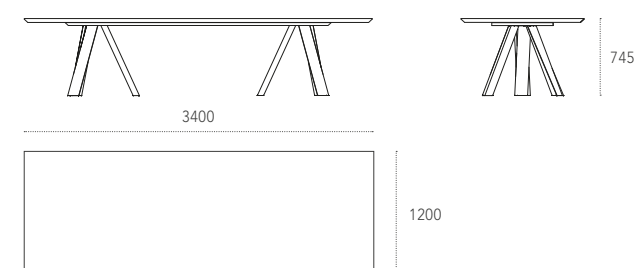

**Ki Round** design: Studio 28

Struttura in metallo verniciato. Piano in legno, vetro o ceramica.  
Painted metal base. Wooden, glass or ceramic top.

Dimensioni - Dimensions (mm)

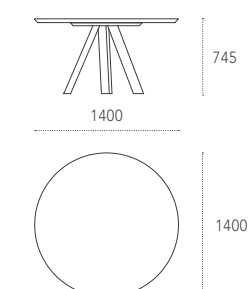





**Mexa** design: Studio 28

Struttura in metallo verniciato. Piano in legno, vetro, metallo o ceramica disponibile in formato rettangolare o sagomato.  
Painted metal base. Wooden, glass, metal or ceramic top, available in two versions: rectangular or shaped.

Dimensioni - Dimensions (mm)

**Piano rettangolare - Rectangular top**

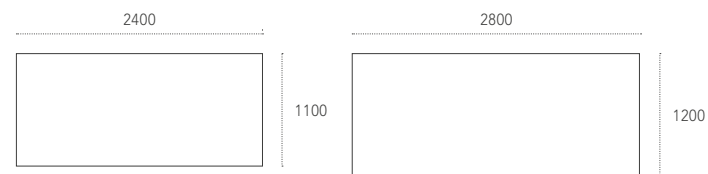
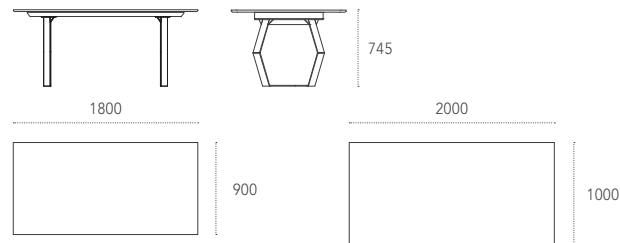

**Piano sagomato - Shaped top**

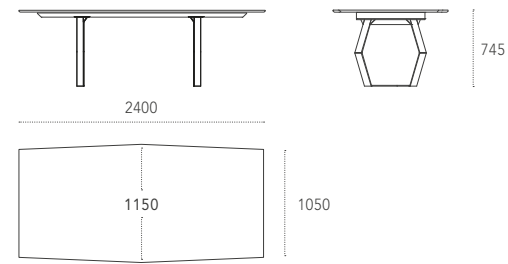

**Tavolo allungabile - Extendable table (H 765 mm)**

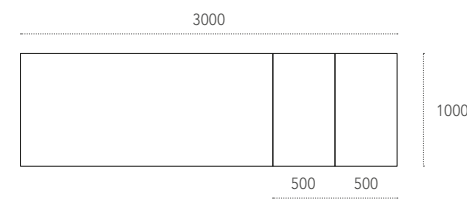

**Slice** design: Studio 28

Struttura in metallo verniciato. Piano in legno, vetro, metallo o ceramica disponibile in formato rettangolare o sagomato.  
Painted metal base. Wooden, glass, metal or ceramic top, available in two versions: rectangular or shaped.

Dimensioni - Dimensions (mm)

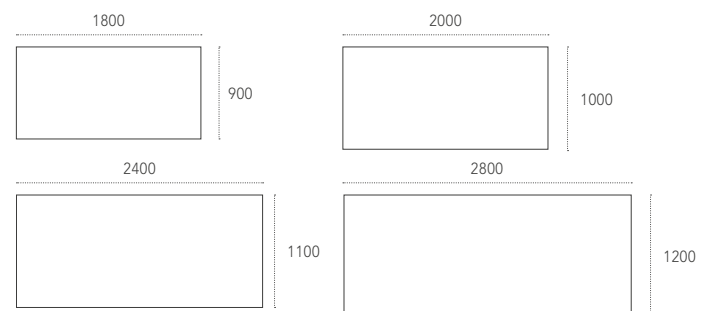
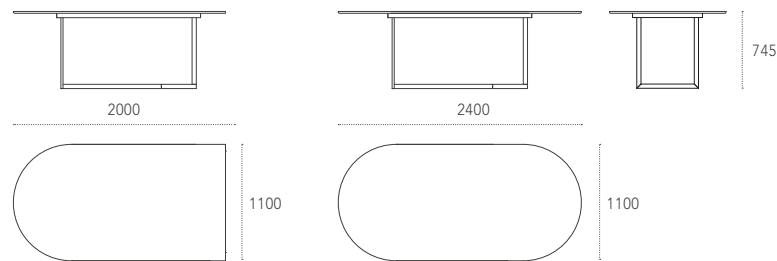

**Twirl** design: Studio 28

Struttura in metallo verniciato. Piano in legno, vetro o ceramica con vassoio rotante.  
Painted metal base. Wooden, glass or ceramic table top with rotating tray.

Dimensioni - Dimensions (mm)

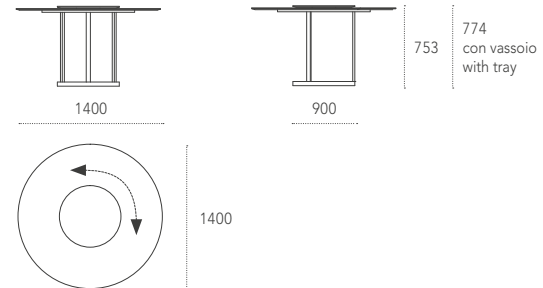

**Gemini** design: Studio 28

Struttura in metallo verniciato. Piano in legno, vetro, metallo o ceramica disponibile in formato rettangolare o sagomato.  
Painted metal base. Wooden, glass, metal or ceramic top, available in two versions: rectangular or shaped.

Dimensioni - Dimensions (mm)

**Piano rettangolare - Rectangular top**

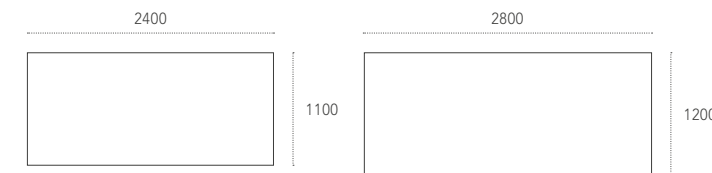
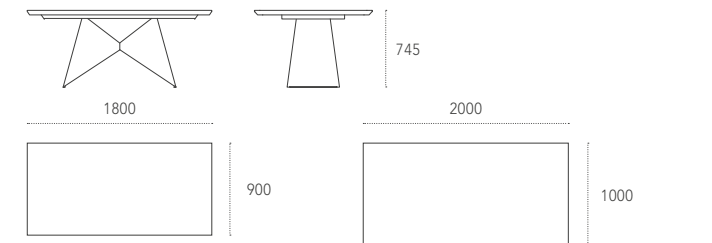

**Piano sagomato - Shaped top**

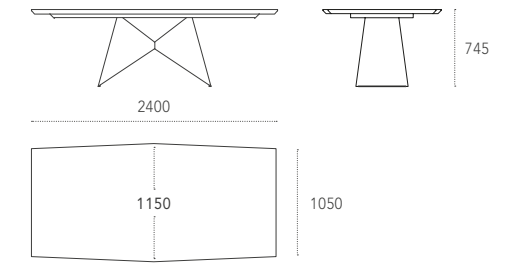

**Quasimodo** design: Adriani e Rossi

Struttura in metallo verniciato. Piano in legno, vetro o ceramica disponibile in formato rettangolare o sagomato.  
Painted metal base. Wooden, glass or ceramic top, available in two versions: rectangular or shaped.

Dimensioni - Dimensions (mm)

**Piano rettangolare - Rectangular top**

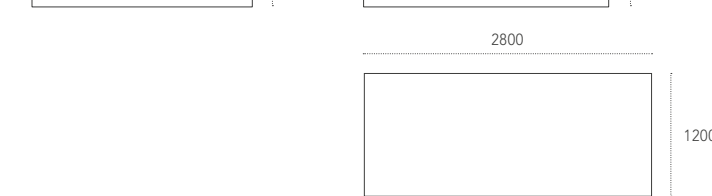
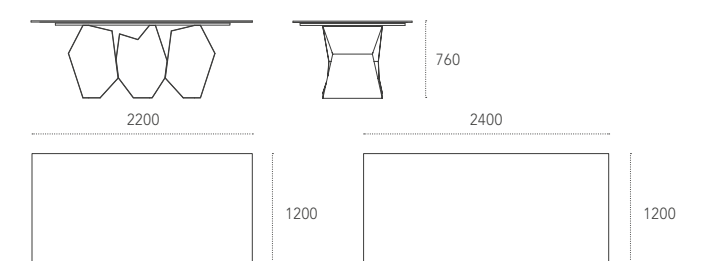

**Piano sagomato - Shaped top**

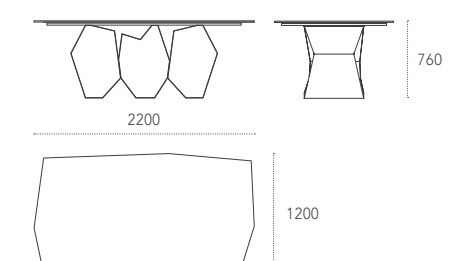





**Opera** design: Studio 28

Struttura in metallo verniciato. Piano in legno, vetro, metallo o ceramica disponibile in formato rettangolare o sagomato.  
Painted metal base. Wooden, glass, metal or ceramic top, available in two versions: rectangular or shaped.

Dimensioni - Dimensions (mm)

**Piano rettangolare - Rectangular top**

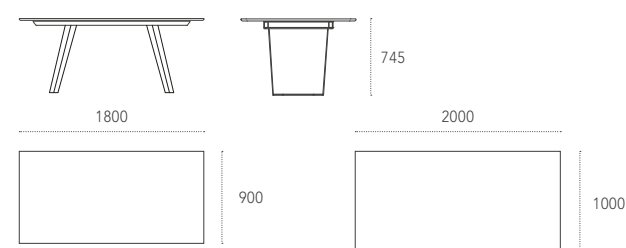

**Piano sagomato - Shaped top**

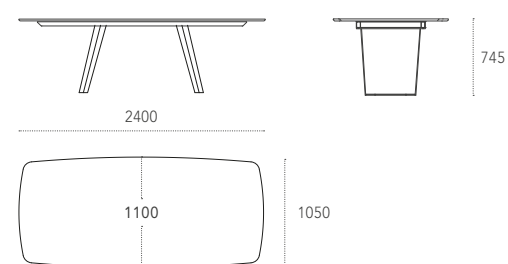

**Tavolo allungabile - Extendable table (H 765 mm)**

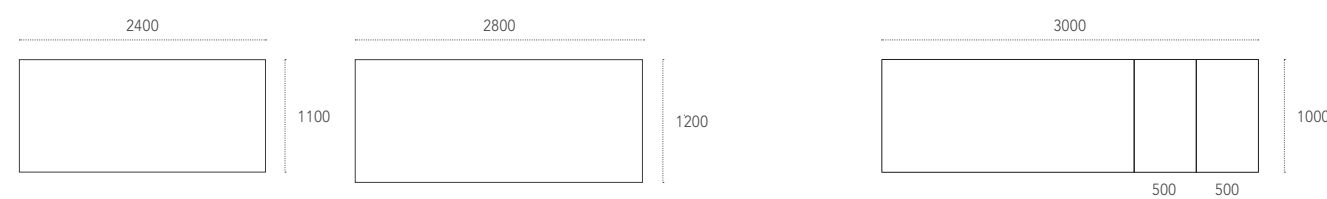

**Panta Rei** design: Studio 28

Struttura in metallo verniciato. Piano in legno, vetro o ceramica.  
Painted metal base. Wooden, glass or ceramic top.

Dimensioni - Dimensions (mm)

**Tavolo fisso - Fixed table**

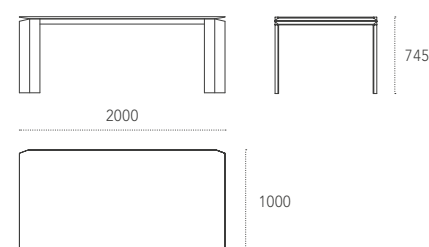

**Tavolo allungabile - Extendable table**

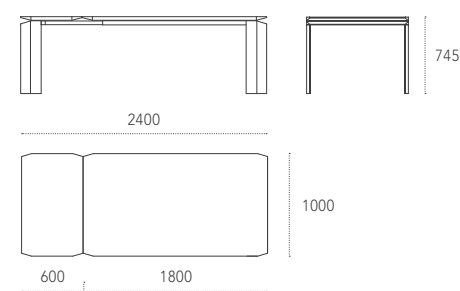

**Asana** design: Studio 28

Base in metallo verniciato. Seduta rivestita in pelle, ecopelle o velluto.  
Painted metal structure. Seat covered in leather, ecoleather or velvet.

Dimensioni - Dimensions (mm)

**Sedia - Chair**

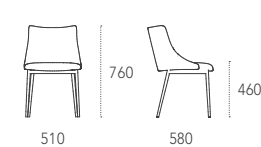

**Poltroncina - Easy chair**

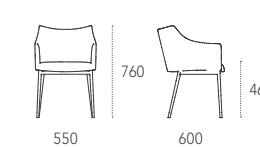

**Sgabelli - Stools**

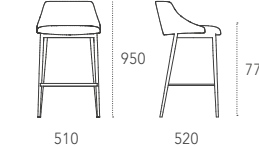
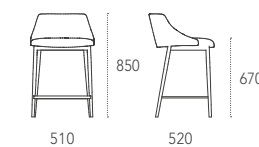

**Nirvana** design: Studio 28

Base in metallo verniciato. Seduta rivestita in pelle, ecopelle o velluto.  
Painted metal structure. Seat covered in leather, ecoleather or velvet.

Dimensioni - Dimensions (mm)

**Sedie - Chairs**

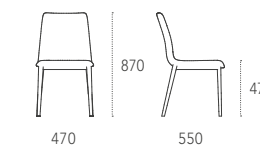
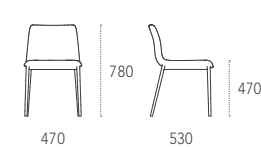

**Sgabelli - Stools**

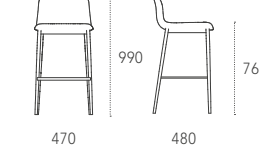
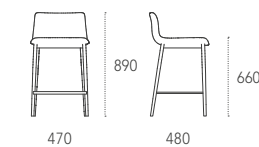

**Izoard** design: Adriani e Rossi

Base in metallo verniciato. Seduta rivestita in pelle o ecopelle.  
Painted metal structure. Seat covered in leather or ecoleather.

Dimensioni - Dimensions (mm)

**Sedia - Chair**

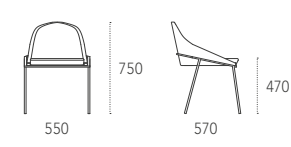





**Mantra** design: Gino Carollo

Base in metallo verniciato. Seduta rivestita in pelle, ecopelle o velluto.  
Painted metal structure. Seat covered in leather, ecoleather or velvet.

Dimensioni - Dimensions (mm)

**Sedia - Chair**

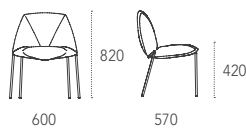

**Sgabelli - Stools**

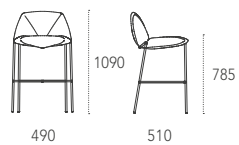

**Mantra** design: Gino Carollo

Poltrona e Pouf con base in metallo verniciato e seduta imbottita rivestita in pelle, ecopelle o velluto.  
Armchair and pouf with metal painted base and upholstered seat in leather, ecoleather or velvet.

Dimensioni - Dimensions (mm)

**Poltrona con poggiatesta - Armchair with headrest**

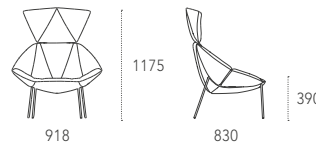

**Poltrona - Armchair**

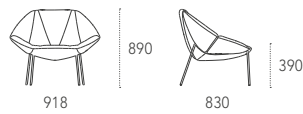

**Pouf - Pouf**



**Otium** design: Studio 28

Pouf con base in metallo verniciato e seduta rivestita in pelle, ecopelle o velluto.  
Painted metal base and seat covered in leather, ecoleather or velvet.

Dimensioni - Dimensions (mm)

**Pouf**

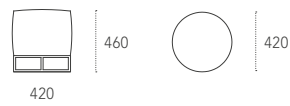

**Nemesi** design: Gino Carollo

Madia rivestita in metallo con ante in legno, ceramica o metallo. Interno nero con ripiani in vetro.  
Metal covered sideboard with wooden, ceramic or metal doors. Black cabinet inside with glass shelves.

Dimensioni - Dimensions (mm)

**3 ante - doors**

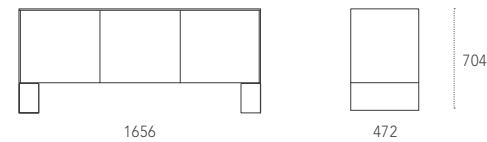

**4 ante - doors**

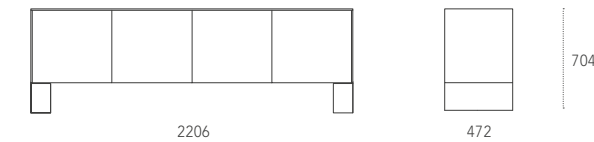

**Doride** design: Studio 28

Madia in legno con piedini in metallo verniciato.  
Wooden sideboard with painted metal feet.

Dimensioni - Dimensions (mm)

**3 ante - doors**

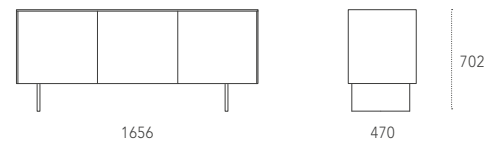

**4 ante - doors**

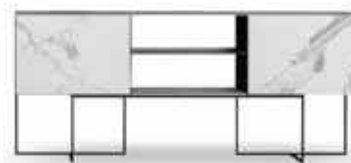
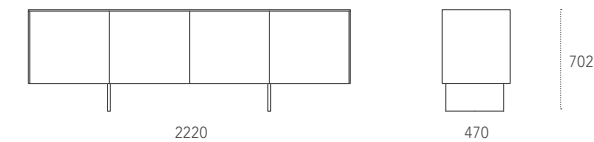

**Bermuda** design: Gino Carollo

Madia in metallo e ceramica con ripiani in vetro. Sistema magnetico sul retro per fissaggio di sicurezza su boiserie della linea Magnetika.  
Metal and ceramic sideboard with glass shelves. Magnetic system on the back for security fixing on the Magnetika metal panels.

Dimensioni - Dimensions (mm)

**2 ante - doors**

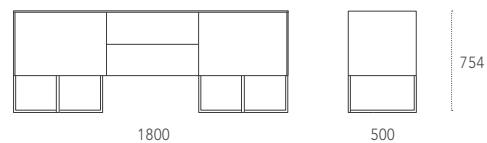





**Soho** design: Ronda Design Lab

Madia rivestita in metallo con telaio di supporto in legno laccato.  
Metal covered sideboard with lacquered wood support frame.

Dimensioni - Dimensions (mm)

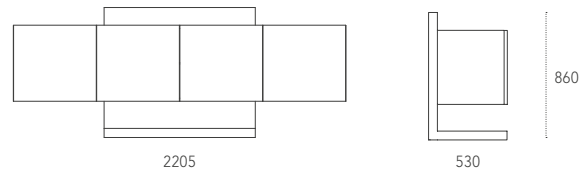

**Bikram** design: Gino Carollo

Madia componibile in legno e metallo. Ogni modulo è disponibile nella versione destra e sinistra.  
Modular metal and wooden sideboard. Every module is available in the right and left version.

Dimensioni - Dimensions (mm)

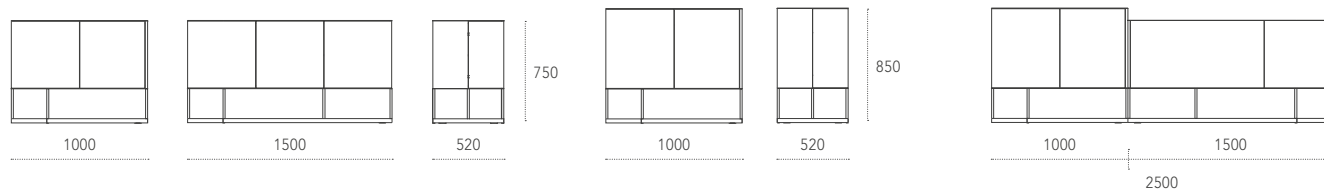

**Levia Console** design: Gino Carollo

Consolle in metallo verniciato.  
Painted metal console

Dimensioni - Dimensions (mm)

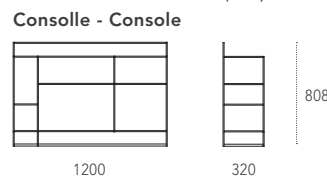

**Levia TV** design: Gino Carollo

Porta tv in metallo verniciato.  
Painted metal Tv stand.

Dimensioni - Dimensions (mm)

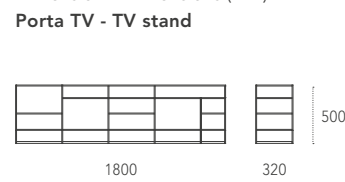

**Birdie** design: Gino Carollo

Consolle o scrivania in metallo con frontale del cassetto in ceramica o metallo.  
Metal console or desk with drawer front in ceramics or metal.

Dimensioni - Dimensions (mm)

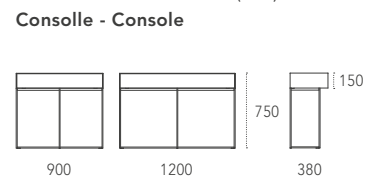

**Scrivania - Desk**

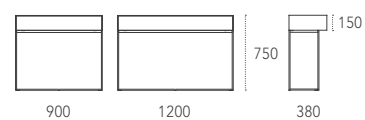

**Levia** design: Gino Carollo

Libreria in metallo verniciato con profili a sezione quadrata da 8mm. Ripiani in ceramica opzionali per Levia Small. Levia Air progettata per montaggio in sospensione.  
Painted metal bookcase with 8mm square section profiles. Optional ceramic shelves for Levia Small. Levia Air designed for suspended mounting.

Dimensioni - Dimensions (mm)

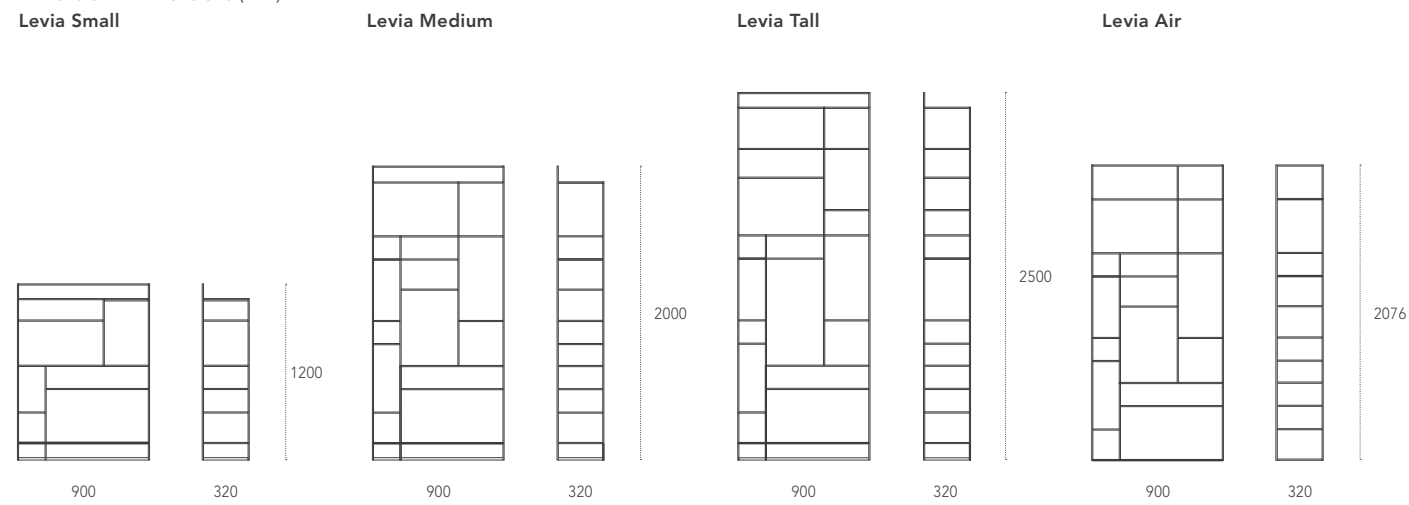

**Polis** design: Gino Carollo

Libreria in metallo verniciato con profilo irregolare. Utilizzabile in appoggio o sospesa. Modularità compatibile con composizioni Caddy.  
Painted metal bookcase with irregular profile. Can be placed on the floor or hung on the wall. Modularity compatible with Caddy compositions.

Dimensioni - Dimensions (mm)

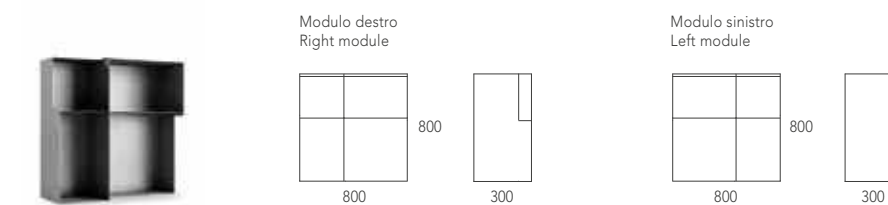

**Libera 45** design: Gino Carollo

Libreria componibile magneticamente. Elementi in legno o metallo verniciato.  
Magnetic modular bookcase. Elements in wood or painted metal.

Dimensioni - Dimensions (mm)

**Esempio composizione - Composition example**

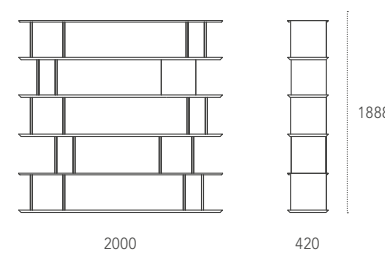

**Ripiani legno - Wooden shelves**

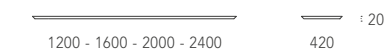

**Ripiani metallo - Metal shelves**



magnetika



**Supporti - Supports**





**Iron-ic** design: Ronda Design Lab

Libreria modulare in metallo, disponibile nella versione base ad incastro e nella versione pensile con angoli saldati.  
Modular metal bookcase, available in the basic version with interlocking joints and in the hanging version with welded corners.

Dimensioni - Dimensions (mm)

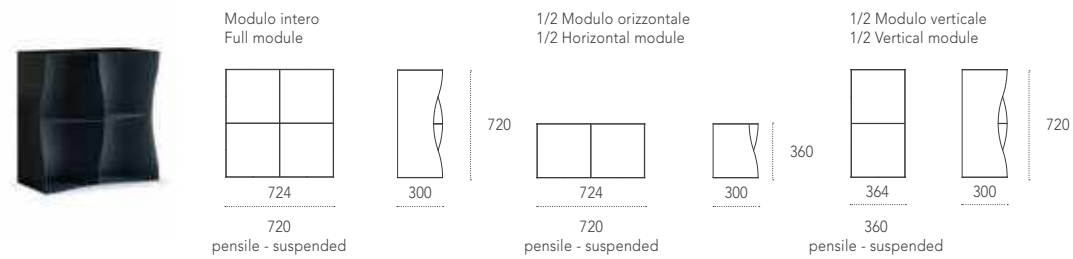

**Iron-ic Shelter** design: Ronda Design Lab

Modulo pensile integrabile nelle composizioni Iron-ic, con rivestimento in metallo e anta battente in legno o metallo.  
Metal covered wall unit that can be integrated into the Iron-ic compositions, with wooden or metal hinged door.

Dimensioni - Dimensions (mm)

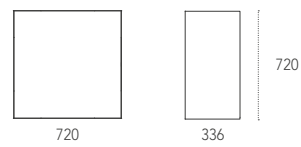

**Iron-ic Glass** design: Ronda Design Lab

Modulo pensile in metallo verniciato con ante in vetro fumé. Integrabile nelle composizioni Iron-ic.  
Suspended module in painted metal with doors in smoked glass. Can be integrated into the Iron-ic compositions.

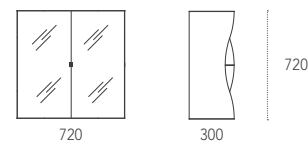

**Su** design: Diego Collareda - Etimodesign

Libreria freestanding in metallo verniciato. Profondità moduli: 250 mm.  
Freestanding bookcase in painted metal. Modules depth: 250 mm.

Dimensioni - Dimensions (mm)

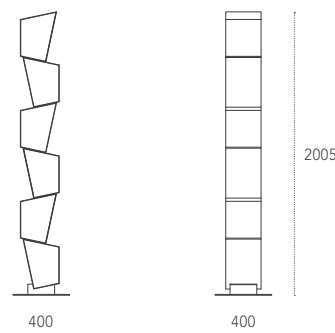

**W Su Line** design: Diego Collareda - Etimodesign

Libreria a parete in metallo verniciato. Utilizzabile in verticale o orizzontale.  
Wall-mounted bookcase in painted metal. Suitable for horizontal or vertical fitting.

Dimensioni - Dimensions (mm)

**Verticale - Vertical**

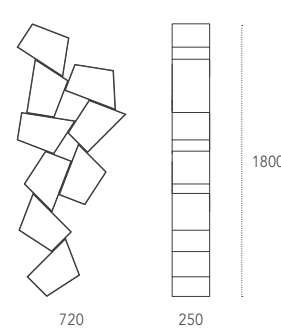

**Orizzontale - Horizontal**

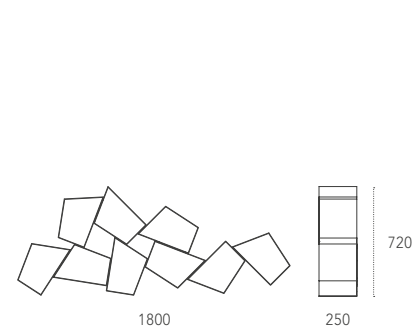

**Ago & Filo** design: Ronda Design Lab

Mensola in legno con elementi in metallo liberamente posizionabili.  
Wooden shelf with metal elements that can be freely positioned.

Dimensioni - Dimensions (mm)

**Mensola in legno - Wood shelf**



**Mensola in metallo - Metal shelf**

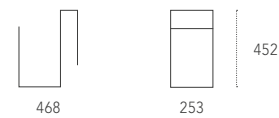

**Esempio - Example**

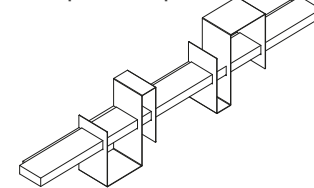

**Optional**  
Illuminazione a Led lungo il bordo inferiore.  
Led lighting along the lower edge.



**Prima** design: Studio 28

Vetrina in cristallo extrachiaro con anta a cerniera laterale e ripiani in cristallo. Base e struttura interna in metallo verniciato. Ripiano inferiore con piastra di illuminazione a led integrata opzionale.  
Display cabinet in extra-clear glass with side hinged door and glass shelves. Painted metal base and internal structure. Optional bottom LED lighting plate.

Dimensioni - Dimensions (mm)

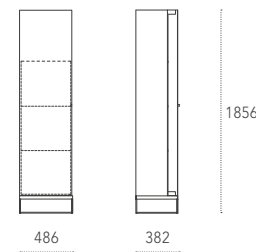

**Bogey** design: Gino Carollo

Comodino in metallo con frontale del cassetto in ceramica o metallo.  
Metal bedside table with drawer front in ceramics or metal.

Dimensioni - Dimensions (mm)

**Comodino - Bedside table**

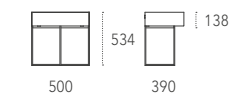

**Axis** design: Gino Carollo

Tavolini in metallo verniciato con ripiano superiore in metallo, legno, ceramica o vetro.  
Painted metal coffee tables with top in metal, wood, ceramic or glass.

Dimensioni - Dimensions (mm)

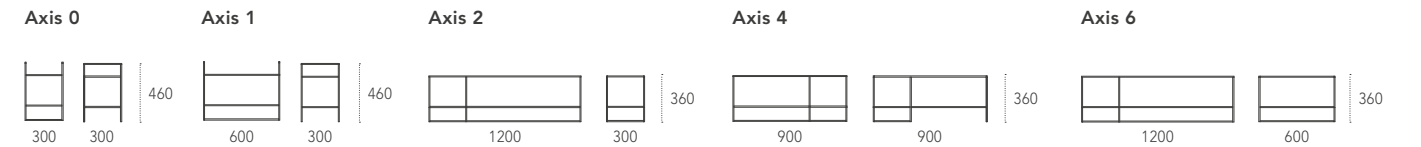

**Atik** design: Gino Carollo

Tavolino asimmetrico in metallo verniciato. Atik medium con cassetto.  
Asymmetrical coffee table in painted metal. Atik medium with drawer.

Dimensioni - Dimensions (mm)

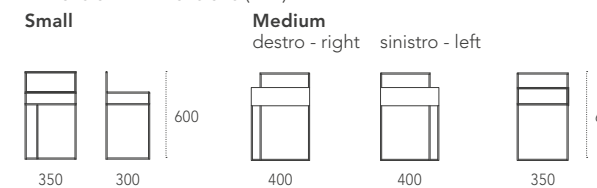

**Eureka** design: Studio 28

Tavolino in metallo verniciato e legno, disponibile in diverse essenze.  
Coffee table in wood and painted metal, available in various kinds of wood.

Dimensioni - Dimensions (mm)

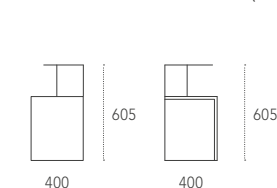





**Ace** design: Luca Roccadadria

Specchio con cornice in metallo verniciato. Mirror with painted metal frame.

Dimensioni - Dimensions (mm)

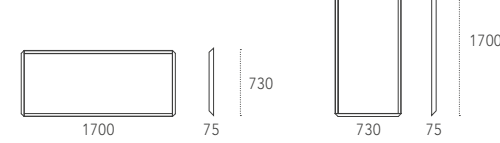

**Ark** design: Studio 28

Set di specchi con cornice in metallo verniciato. Set of mirrors with painted metal frame.

Dimensioni - Dimensions (mm)



**Snow** design: Gino Carollo

Specchio magnetico con cornice in metallo verniciato. Fissabile anche a parete. Snow 02 con retroilluminazione led opzionale, da utilizzare con binario elettrificato. Magnetic mirror with painted metal frame. Can also be hung on the wall. Snow 02 with optional led backlighting, to be used with electrified track.

Dimensioni - Dimensions (mm)

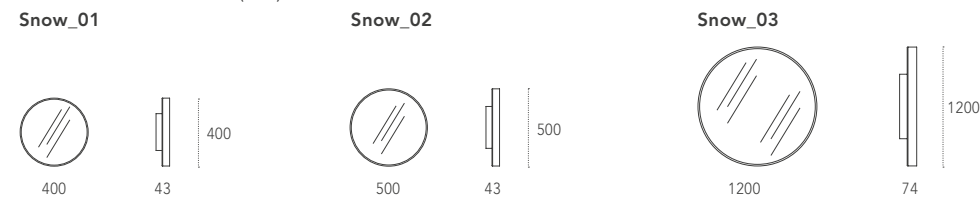

**Esagoni** design: Ronda Design Lab

Specchio esagonale magnetico. Fissabile anche a parete con apposito lamierino posteriore. Magnetic hexagonal mirror. Can also be fixed to the wall with a special back plate.

Dimensioni - Dimensions (mm)

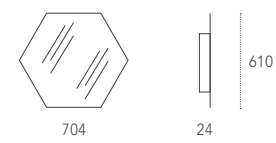

**Jazz** design: Studio 28

Specchio magnetico con cornice in legno. Fissabile anche a parete. Magnetic mirror with wooden frame. Can also be hung on the wall.

Dimensioni - Dimensions (mm)

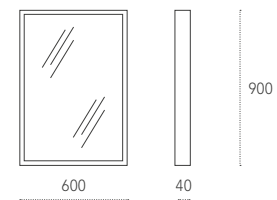

**Wink** design: Gino Carollo

Set di fioriere in metallo verniciato, disponibile nella versione a terra su ruote o in appoggio su telaio. Painted metal planters set, available on wheels or resting on a frame.

Dimensioni - Dimensions (mm)

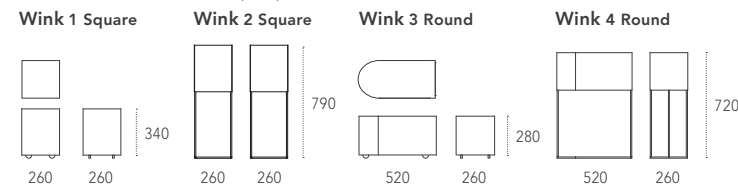

**Spot** design: Studio 28

Carrello portavivande in metallo verniciato con ripiano in ceramica o metallo. Tagliere ad incastro opzionale. Painted metal food trolley with ceramic or metal top. Optional chopping board.

Dimensioni - Dimensions (mm)

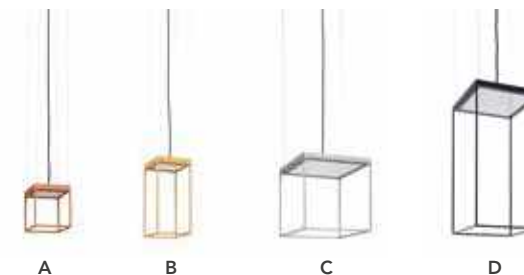
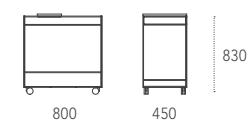

**Brassie** design: Gino Carollo

Lampada a sospensione con piastra Led e struttura in metallo verniciato con profilo quadrato. Disponibile con rosone singolo o in composizioni di 3, 4 o 5 lampade. Cavi in acciaio da 1,2 mt, disponibili anche nelle lunghezze extra di 3 mt e 5 mt. Cavo elettrico rivestito in tessuto argento o nero. Painted metal suspended lamp with LED lighting plate and squared profile structure. Available with single ceiling rose or in combinations of 3, 4 or 5 lamps. 1,2 mt long steel cables, also available in the extra length of 3 mt and 5 mt. Fabric covered electric cable, silver or black finish.

Dimensioni - Dimensions (mm)

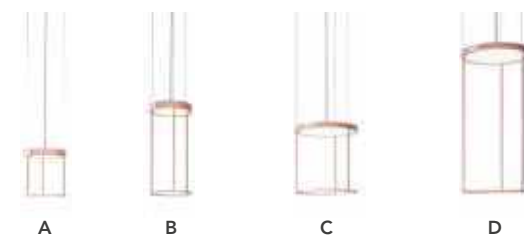
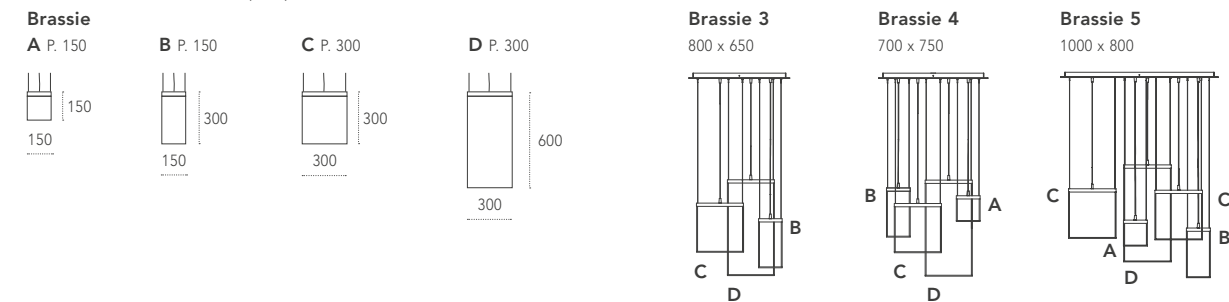

**Brassie Round** design: Gino Carollo

Lampada a sospensione con piastra Led tonda e struttura in metallo verniciato con profilo quadrato. Rosone singolo e cavi in acciaio da 1,2 mt, disponibili anche nelle lunghezze extra di 3 mt e 5 mt. Cavo elettrico rivestito in tessuto argento o nero. Painted metal suspended lamp with round LED lighting plate and squared profile structure. Single ceiling rose and 1,2 mt long steel cables, also available in the extra length of 3 mt and 5 mt. Fabric covered electric cable, silver or black finish.

Dimensioni - Dimensions (mm)

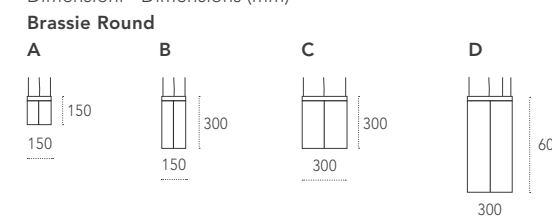

**Lift** design: Studio 28

Lampada a sospensione con piastra Led tonda orientabile e struttura in metallo verniciato. Rosone singolo e cavo elettrico rinforzato trasparente o nero. Painted metal suspended lamp with rotating LED plate. Single ceiling rose and transparent or black reinforced electric cable.

Dimensioni - Dimensions (mm)

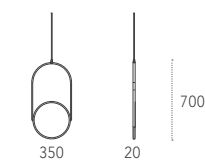





**Chia** design: Gino Carollo

Lampada da tavolo con struttura in metallo verniciato. Led a luce calda 3000 k con batteria ricaricabile. Painted metal table lamp. Warm light LED (3000 k) with rechargeable battery.

Dimensioni - Dimensions (mm)

P. 110

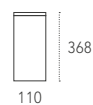

**Brand** design: Saverio Incombeni

Lampada magnetica in metallo verniciato, utilizzabile anche in appoggio. Led a luce calda 3000 k con batteria ricaricabile. Magnetic lamp in painted metal that can also be used as a table lamp. Warm light LED (3000 k) with rechargeable battery.

Dimensioni - Dimensions (mm)

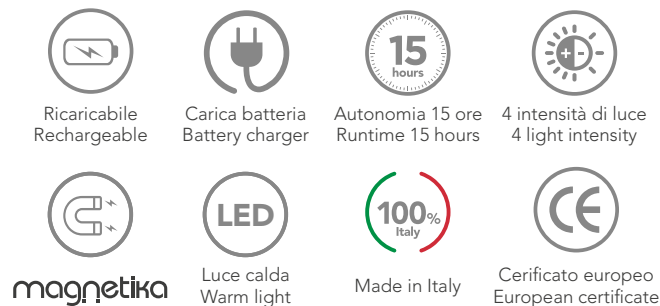
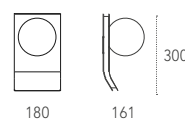

**Lapilla** design: Debonademeo

Lampada magnetica composta da base e paralume in metallo, liberamente posizionabili sulle boiserie metalliche della linea Magnetika. Disponibile ad alimentazione elettrica o con batteria ricaricabile. Magnetic lamp composed of a metal base and a lampshade, which can be freely positioned on the metal paneling of the Magnetika line. Available with electric power supply or with rechargeable battery.

Dimensioni - Dimensions (mm)

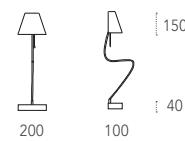

**Lift Floor** design: Studio 28

Lampada da terra con piastra led orientabile in metallo verniciato. Floor lamp with adjustable led plate and painted metal structure.

Dimensioni - Dimensions (mm)

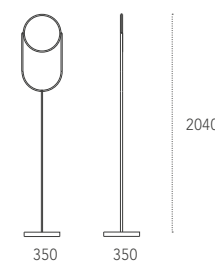

**Pivot** design: Studio 28

Lampada da terra in metallo con quattro piccoli piani d'appoggio in metallo, vetro e ceramica. Illuminazione con piastra Led posizionata sotto il piano superiore. Painted metal floor lamp with four small shelves made of metal, glass and ceramics. Led panel positioned beneath the top shelf.

Dimensioni - Dimensions (mm)

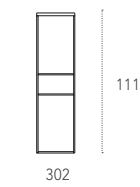

**Ronda Design** si riserva la facoltà di modificare in qualunque momento e senza preavviso, le caratteristiche tecniche degli elementi presenti nel catalogo. Alcuni accessori presenti nelle immagini fotografiche non sono prodotti da **Ronda Design**. Si prega di far riferimento al listino prezzi.

**Ronda Design** si riserva inoltre il diritto di apportare ai propri prodotti quelle modifiche che riterrà necessarie o utili al fine di migliorarli senza pregiudicarne le caratteristiche essenziali. È vietata ogni riproduzione totale e parziale in Italia e all'estero.

Le finiture e i colori sono indicativi e possono subire variazioni dovute alla tecnica di stampa.

**Ronda Design** is entitled to modify the technical features of the elements displayed in this catalogue at any time and without giving notice. Some of the accessories shown in the photographs are not produced by **Ronda Design**. Please refer to the price list.

**Ronda Design** is entitled to make any modification to its products that it deems necessary or useful to improve them without changing their essential features. Any total or partial reproduction in Italy or abroad is forbidden.

Finishings and colours are approximate and they may vary due to the printing process.





## Realizzazioni e idee Projects and ideas



Visita la sezione riservata del sito Ronda Design  
Visit the reserved area of the Ronda Design website



rondadesign >

App Design S.r.l. Via G. Galilei, 31 - 36010 Zanè (VI) - Italy  
Tel. +39 0445 1850142 Fax +39 0445 1850143  
sales@rondadesign.it www.rondadesign.it

Printed in Italy September 2020