

ZECCHINON

KITCHEN
Collection



CONTENTS

01	KITCHENS COLLECTION	06
	T80	08
	T70	20
	PROFILE COLLECTION	38
	KATE	
	KELLY	
	ISABEL	
	ALEXIA	
	K105	80
	FRAME	
	YOUNG COLLECTION	104
	TIFFANY	
	CLOË	
	POLIMERIC COLLECTION	120
	KALEA	
	QUADRA	
02	COMPLEMENTS	132
03	ATTREZZARE ED ORGANIZZARE	156
	Équiper et organiser / Fitting and organising	
04	TAVOLI ESTRAIBILI / TAVOLI	186
	Table extractible / Table Pull-out table / Table	
05	MATERIALS	204

ZECCHINON

Since 1949

Da oltre 70 anni lavoriamo con impegno, dedizione e attenzione alla cura dei dettagli ma soprattutto con tanta passione, in una sintesi di artigianalità e tecnologia. Siamo protagonisti nel settore delle cucine poiché ci impegniamo ogni giorno nel realizzare prodotti curati e ricchi di qualità, capaci di migliorare la vita delle persone e di esprimere valori che durano nel tempo. Fra tradizione e futuro è una sfida continua che affrontiamo ogni giorno con energia e patrimonio di conoscenza.

Depuis plus de 70 ans, nous travaillons avec engagement, dévouement et attention aux détails, mais surtout avec beaucoup de passion, dans une synthèse d'artisanat et de technologie. Nous sommes un acteur de premier plan dans le secteur de la cuisine parce que nous nous engageons chaque jour à fabriquer des produits soignés et de haute qualité qui améliorent la vie des gens et expriment des valeurs durables. Entre tradition et avenir, c'est un défi permanent que nous relevons chaque jour avec énergie et richesse de connaissances.

For over 70 years we have been working with commitment, dedication and attention to detail but, above all, with a great deal of passion, in a synthesis of craftsmanship and technology. We are protagonists in the kitchen sector because we are committed every day to creating well-designed products that are rich in quality, capable of improving people's lives and expressing timeless values. Merging tradition and future is a continuous challenge that we face each and every day, with energy and a wealth of knowledge.



Design and Made in Italy



La capacità manuale e artigianale italiana mette in evidenza tutte le caratteristiche della sua identità legate alla bellezza, alla cultura ed al piacere stesso di crearla. Per noi essere identificati come industriali artigiani è motivo di orgoglio. Questo è un valore che è rimasto sempre costante nel tempo, riconosciuto dal mondo intero che rimane affascinato dalla ricerca, dalla cura, dalla qualità e dalla creatività delle nostre realizzazioni.



La capacità manuale e artigianale italiana mette in evidenza tutte le caratteristiche di sua identità legate alla bellezza, alla cultura e al piacere stesso di crearla. Per noi, essere identificati come artigiani industriali è una fonte di orgoglio. Questo è un valore che è rimasto costante nel tempo, riconosciuto dal mondo intero che resta affascinato dalla ricerca, dalla cura, dalla qualità e dalla creatività delle nostre realizzazioni.

Italian manual and craft ability highlights all the characteristics of its identity linked to beauty, culture, and the pleasure itself of creating. For us, being identified as industrial craftsmen is a source of pride. This is a value that has always remained constant over time, recognized by the whole world, fascinated by the research, care, quality and creativity of our achievements.

LA NOSTRA REALTÀ

La struttura aziendale è attualmente articolata in tre unità operative che comprendono il centro direzionale, il company showroom e le aree dedicate alla produzione per una superficie coperta totale di circa 40.000 mq. Componenti e materie prime vengono selezionati ed acquistati dai migliori fornitori in Italia e nel mondo.

Siamo un'azienda dallo spirito internazionale ma con forti radici in un territorio, quello del Veneto, che ha saputo conservare i propri valori e le proprie tradizioni. Una cultura del lavoro come valore sociale che ci ha permesso di saper sempre coniugare da oltre 70 anni il legame con le nostre culture passate e la voglia di progredire.

Identity

Quality

Research



Notre réalité. La structure de l'entreprise est actuellement articulée en trois unités opérationnelles comprenant le centre de direction, le centre-phare de l'entreprise et les zones dédiées à la production, sur une surface couverte totale d'environ 40.000 m². Les composants et les matières premières sont sélectionnés et achetés auprès des meilleurs fournisseurs, en Italie et dans le monde. Nous sommes une entreprise qui a un esprit international, mais avec de fortes racines dans un territoire qui est celui du Veneto, qui a su garder ses propres valeurs et ses propres traditions. La culture du travail comme une valeur sociale nous a permis, depuis plus de 70 ans, de maintenir le lien entre nos cultures passées et l'envie d'avancer.

Our company. The company is currently structured into three operating units that include central management, the corporate flagship store and the areas dedicated to production, on a total covered area of approximately 40,000 sq. m. Components and raw materials are selected and purchased from the best suppliers in Italy and in the world. Our company has an international spirit with strong roots in one territory, the Veneto territory, which was able to treasure its values and traditions. For over 70 years, a work culture as social value allowed us to combine the bond between our past cultures and the desire of progressing.

01

KITCHENS COLLECTION

- **T80**
- **T70**
- **PROFILE COLLECTION**
 - KATE
 - KELLY
 - ISABEL
 - ALEXIA
- **K105**
 - FRAME
- **YOUNG SOUL COLLECTION**
 - TIFFANY
 - CLOË
- **POLIMERIC COLLECTION**
 - KALEA
 - QUADRA

La collezione Zecchinon concezione della cucina che coniuga forte caratterizzazione e massima qualità.

Una coerenza stilistica che si declina attraverso proposte dalla personalità decisa, fra dettagli tecnici e originali abbinamenti materici.

La collezione Zecchinon un concept de cuisine qui allie caractère fort et qualité supérieure. Une cohérence stylistique qui s'exprime par des propositions à forte personnalité, des détails techniques et des combinaisons de matériaux originales.

The Zecchinon collection a concept of the kitchen that combines strong characterisation and maximum quality. A stylistic coherence that is expressed through proposals with a strong personality, between technical details and original combinations of material.



T80

Progetto innovativo ed esclusivo, le ante spessore 12 mm realizzate con la tecnologia in alveolare di alluminio, sono estremamente leggere e resistenti alla flessione.



SEZIONE

Section
Section

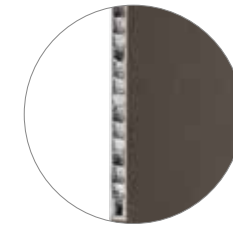

SISTEMI DI APERTURA

Système d'ouverture
Opening system

GOLA SYSTEM KAPPA



MANIGLIA

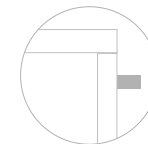

PUSH-PULL



D'un design innovant et exclusif, les portes de 12 mm d'épaisseur réalisées avec la technologie alvéolaire en aluminium sont extrêmement légères et résistantes à la flexion. Innovative and exclusive project, the 12 mm thick doors made with aluminium honeycomb technology, are extremely light and resistant to bending.



L'abbinamento fra il Metal Dust Bronze e la ceramica Umbrà Marron Abujardado fa risaltare le forme ed i volumi dell'intera cucina, dove spiccano due isole raccordate da un leggero e prezioso elemento a giorno.

La combinaison du Metal Dust Bronze et de la céramique Umbrà Marron Abujardado fait ressortir les formes et les volumes de toute la cuisine, où se distinguent deux îlots reliés par un élément ouvert léger et précieux.

The combination of the Metal Dust Bronze and the Umbrà Marron Abujardado ceramic brings out the shapes and volumes of the entire kitchen, where two islands connected by a light and precious open element stand out.





Metal Dust Bronze

Olmo Carruba

MDi by Inalco Umbra





Spazi per riporre o esporre: Yuki, colonna a giorno con luce, dove gli oggetti più belli della casa diventano protagonisti e il comodo ripostiglio per celare gli utensili di tutti i giorni.

Espaces de rangement ou d'exposition : Yuki, colonne ouverte avec lumière, où les plus beaux objets de la maison deviennent protagonistes et l'espace de rangement pratique pour cacher les ustensiles de tous les jours.

Storage or display spaces: Yuki, open tall unit with light, where the most beautiful objects of the house become protagonists and the convenient storage closet to hide everyday utensils from view.



Rovere Termocotto
Olmo Biondo
Laccato Opaco Roccia
Rock Rk1 Basalto
Dekton Fossil





Noce Canaletto
 Metal Dust Md1 Bronze
 Laccato Opaco Soia
 Laminam In-Side Porfido Marrone Fiammato





T70

Un telaio in alluminio che supporta svariati materiali quali la preziosa e naturale ceramica, il vetro, le essenze e molto altro, liberando così le più sofisticate fantasie progettuali.



PROFILO
 Profil
 Profile



FINITURE TELAIO
 Finitions du cadre
 Frame finishes



BRONZO
 TITANIO



CHAMPAGNE

Un cadre en aluminium qui supporte une variété de matériaux tels que des matériaux précieux, des céramiques naturelles, du verre, du bois et bien d'autres encore, libérant ainsi les fantasies de conception les plus sophistiquées.

An aluminium frame that supports various materials such as precious and natural ceramics, glass, wood and much more, thus making way for the most sophisticated design imagination.





Le système innovant Revego permet de fermer de manière simple et intuitive les espaces de travail lorsqu'ils ne sont pas utilisés. L'absence de poignée crée un style agréable et épuré. Une solution mécanique qui offre un très haut niveau de confort de mouvement tant à l'ouverture qu'à la fermeture.

The innovative Revego system allows the closure of operating spaces when they are not in use in a simple and intuitive way. The absence of a handle creates a pleasant, clean style. A mechanical solution that offers a very high comfort of movement both in opening and closing.



L'innovativo sistema Revego permette la chiusura degli spazi operativi quando non sono in uso in modo semplice e intuitivo.

L'assenza di maniglia crea una gradevole pulizia di stile. Una soluzione meccanica che offre un confort di movimento molto elevato sia in apertura che in chiusura.

MDi by Inalco Balcan

Laccato Opaco Roccia

Olmo Gold

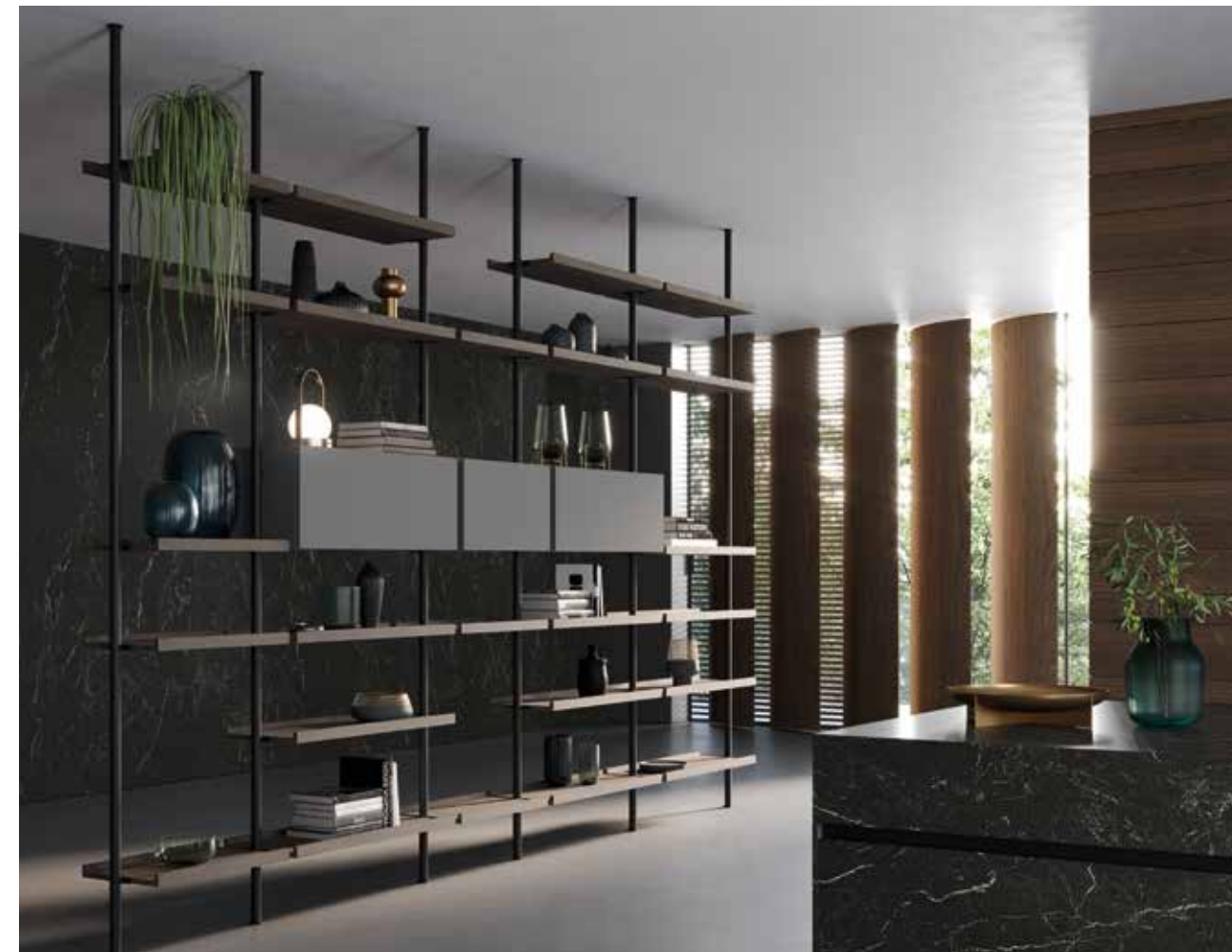





Laminam Pietra Piasentina
Grigio Fiammato

Laminato Hpl Peltro

Olmo Carruba



Il lavello in ceramica si fonde con il piano di lavoro e crea un unico blocco minimale, evidenziato dalle dolci forme dello snack.

L'évier en céramique se marie avec le plan de travail pour créer un seul bloc minimaliste, mis en valeur par les formes douces du snack.

The ceramic sink blends with the worktop and creates a single minimal block, highlighted by the soft shapes of the snack bar.







Olmo Biondo

Fenix Zinco Doha

MDi by Inalco Selene



Abbinamenti ricercati e studiati, come la finitura champagne del metallo, unita alla ceramica Selene per un ambiente dal risultato sofisticato.

Des combinaisons sophistiquées et étudiées, comme la finition champagne du métal, associées à la céramique Selene pour un environnement au résultat sophistiqué.

Refined and studied combinations, such as the champagne finish of the metal, combined with the Selene ceramic for an environment having a sophisticated look.







Rovere Grano
Laccato Opaco Camoscio
MDi by Inalco Ananda



PROFILE COLLECTION

Una famiglia di profili dal differente design estetico e costruttivo danno vita ad accattivanti collezioni dalle pratiche prese ed avvalorano materiali e soluzioni compositive.

Une famille de profils aux designs esthétiques et constructifs différents donne vie à collections captivantes aux prises pratiques et donne rélevance aux matériaux et au design.

A family of profiles with different aesthetic and constructive design giving life to captivating collections with functional grips and giving strenght to materials and design.

SISTEMI DI APERTURA

Système d'ouverture
Opening system

KATE



KELLY



ISABEL

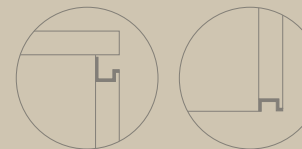

ALEXIA



FINITURE PROFILO

Finitions profil
Profile finishes



BRONZO
TITANIO



ACCIAIO
SATINATO



BRONZO
TITANIO



ACCIAIO
SATINATO



CHAMPAGNE



LACCATI
Laqué / lacquered



BRONZO
TITANIO



ACCIAIO
SATINATO



BRONZO
TITANIO



ACCIAIO
SATINATO



KATE

Kate, arricchita da nuovi materiali che la rendono preziosa e ricercata, è stata studiata per agevolare la presa dell'anta: l'apertura senza maniglia consente la massima pulizia estetica e praticità d'uso.



Kate, arricchita da nuovi materiali che la rendono più preziosa e ricercata, è stata studiata per facilitare la presa della porta: l'apertura senza maniglie permette il miglior nettoyage estético e la pratica d'utilizzo.

Kate, enriched with new materials that make it precious and refined, was developed to facilitate the door grabbing: the opening without handles allow the maximum clean look and ease of use.



Rovere Grano

Metallo Liquido Magnesio

Laminato Hpl Sahara Noire





Anta plissè e colonna a giorno Yuki, un insieme perfetto per una soluzione di design dal sapore contemporaneo.

Porte plissée et colonne ouverte Yuki, une combinaison parfaite pour une solution de design contemporain.

Pleated door and Yuki open tall unit, a perfect combination for a design solution with a contemporary flavour.

Anta PLISSÉ

Un gioco tridimensionale di luci e ombre caratterizza quest'anta dal forte carattere



Un jeu tridimensionnel d'ombre et de lumière caractérise cette porte au caractère bien trempé

A three-dimensional play of light and shadow characterises this door with a strong character

DISPONIBILE PER:

Disponibles pour :
Available for:

K105
Kate
Kelly

MATERIALS

Essenze
Laccato





Melaminico Metal Grey
Rovere Castoro Plissé
Laminato Hpl Mailand









KELLY

Un modello deciso e raffinato che incontra le esigenze della vita quotidiana grazie al connubio tra estetica e funzionalità.

Kelly si distingue per i suoi esclusivi bordi a 30 gradi che offrono una comoda presa per l'apertura degli elementi, senza l'uso di maniglie e si propongono come una soluzione progettuale capace di dar vita ad una cucina dalle linee essenziali e moderne.



Un modèle raffiné qui répond aux besoins de la vie quotidienne grâce à la combinaison de esthétique et fonctionnalité. Kelly se distingue par ses bords exclusifs à 30 degrés qui offrent une prise confortable pour ouvrir les éléments sans poignées et qui sont proposés comme une solution capable de donner vie à cuisines aux lignes essentielles et modernes.

A strong and refined model that meets the needs of everyday life thanks to the combination of aesthetics and functionality. Kelly stands out for its exclusive 30-degree edges that offer a comfortable grip for opening elements without the use of handles and are proposed as a design solution for kitchens with essential and modern lines.



Rovere Grano

Laccato Opaco Soia

Laminam Travertino Grigio Bocciardato







Rovere Lava
Laminato Hpl Himalaya





Olmo Carruba
Fenix Grigio Efeso
Marmo Grigio Armani



ISABEL

Il modello Isabel nasce dall'esigenza di creare una gola integrata nell'anta, una soluzione originale che unisce praticità ed estetica. In questo modello tecnologia e grafismo si articolano in perfetta sinergia con i materiali che la caratterizzano.



Le modèle Isabel est né de la nécessité de créer une gorge intégrée à la porte, une solution originale qui allie praticité et esthétique. Dans ce modèle, la technologie et le graphisme s'articulent en parfaite synergie avec les matériaux qui le caractérisent.

Isabel was born from the need to create a groove integrated into the door, an original solution that combines practicality and aesthetics. In this model technology and graphism are articulated in perfect synergy with the materials that characterize it.



Melaminico Quercia Juta
Melaminico Tanno
Granito Alaska White



COLONNA ANGOLO STORAGE

Colonne d'angle
Corner tall unit closet



Colonna che consente di sfruttare in tutta la sua ampiezza una zona angolare della cucina.
A differenza delle colonne ad angolo tradizionali, questa soluzione permette di entrare fisicamente nella colonna, offrendo la possibilità di essere allestita internamente e di inserire alcuni elettrodomestici da libera installazione.

Colonne permettant d'utiliser pleinement un coin de la cuisine.
Contrairement aux colonnes d'angle traditionnelles, cette solution permet d'entrer physiquement dans la colonne, offrant ainsi la possibilité d'être aménagée à l'intérieur et d'insérer certains appareils électroménagers autoportants.

Tall unit that allows you to take advantage of a corner area of the kitchen in all its amplitude.
Unlike traditional corner tall units, this solution allows you to physically enter the tall unit, offering the possibility of equipping it internally and inserting some freestanding appliances.





Melaminico Rovere Corteccia
Melaminico Calce Brown
Laminato Graniglia



ALEXIA

Alexia è una cucina che reinterpreta un classico senza tempo: una maniglia integrata come segno distintivo, una presa pratica e semplice, un pensiero progettuale legato ad uno stile di carattere tradizionale.



Alexia est une cuisine qui réinterprète un classique intemporel: une poignée insérée comme caractéristique, une prise pratique et simple, une pensée de conception liée à un style de caractère traditionnel.

Alexia is a kitchen model that reinterprets an ageless classic: an integrated handle as a distinctive sign, a practical and easy grabbing, a design thought connected with a traditional style.



Laccato Opaco Soia
Laccato Opaco Antracite
Laminato Ardesia





Melaminico Wood Noce

Laccato Opaco Roccia

Laccato Opaco Bianco

Dekton Zenith





K105

K105 Collection nasce dalla cura dei dettagli, dalla ricerca dei materiali, dall'attenzione alle esigenze di un pubblico eterogeneo ed internazionale, dalla passione per il design e dal nostro modo di essere italiani. Una collezione versatile e funzionale che offre un'infinita libertà compositiva per interpretare gli stili di vita e i trend più contemporanei.

SISTEMI DI APERTURA

Système d'ouverture
Opening system

GOLA
SYSTEM KAPPA



MANIGLIA



PUSH-PULL



K105 collection naît du soin des détails, de la recherche des matériaux, de l'attention aux exigences d'un public hétérogène et international, de la passion pour le design et de notre façon d'être italiens. Une collection versatile et fonctionnelle qui offre une infinie liberté de composition pour interpréter des styles de vie et les tendances plus contemporaines.

K105 collection is the result of attention to detail, the research of materials, focus on heterogeneous and international customer needs, passion for design and our way of being Italian. A versatile and functional collection that offers infinite composition freedom to interpret the most modern lifestyles and trends.



Fenix Bronzo Doha
Melaminico Quercia Caffè
Laccato Opaco Sabbia
MDi by Inalco Meteora









Noce Canaletto
Acciaio Satinato
Dekton Entzo



Olmo Carruba
Laminato Hpl Himalaya
Laccato Opaco Corda

Old Metal Metallo Liquido Oro Rosa
Rovere Castoro
Laccato Opaco Caramello
Dekton Kelya

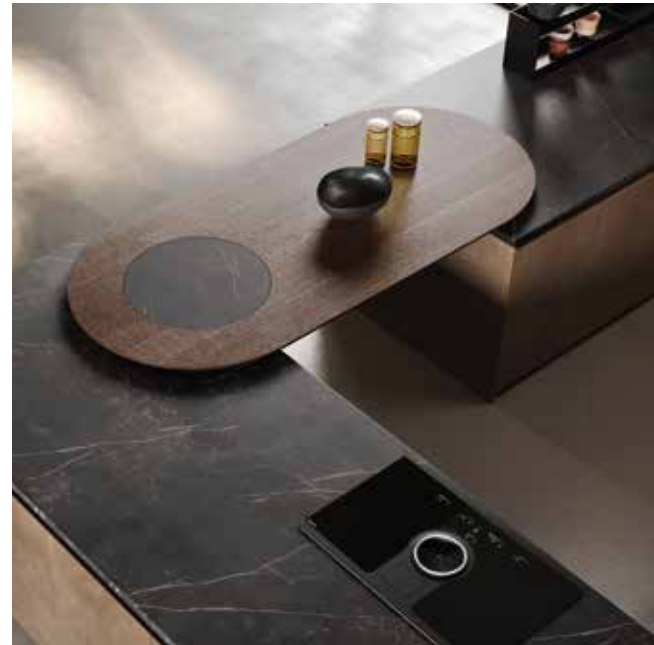



Laminato Hpl Perlino
 Rovere Silvery
 Fenix Grigio Londra



Metallo Liquido Magnesio
 Rovere Termocotto
 Laminato Hpl Statuario



Laccato Opaco Camoscio
Rovere Tavolato Biscotto
Rovere Ghianda
Melaminico Ossido Perla
Marmo Grigio Armani





Legno Antico Abete Multicolor
Metallo Liquido Oro Rosa
Dekton Radium



La finitura Zecchinon "Legno Antico" viene ricavata da legni invecchiati dagli ottanta ai cento anni, recuperati dalle parti esterne di vecchi chalet e baite di montagna. Lavorati con artigianalità e passione, rivivono i tempi moderni portando un po' di storia nelle cucine delle nostre case.

La finition vieux bois de Zecchinon est obtenue à partir de bois âgés de quatre-vingts à cent ans, récupérés des parties extérieures de vieux chalets et refuges de montagne. Travaillé avec savoir-faire et passion, ils retournent en vie en apportant un peu d'histoire aux cuisines de nos maisons.

Zecchinon's old wood finish is obtained from woods aged eighty to one hundred years, obtained from the external parts of old chalets and mountain huts. Worked with craftsmanship and passion, it lives again in modern times bringing a bit of history to the kitchens of our homes.





K105 FRAME

Uno stile tradizionale caratterizza l'anta a telaio, reinterpretato in chiave moderna, arricchito da tagli geometrici ben definiti e da una versatilità espressa nell'ampia modularità.



- ROVERE PAGLIA
- ROVERE ALASKA

SISTEMI DI APERTURA

Système d'ouverture
Opening system

GOLA
SYSTEM KAPPA



MANIGLIA



PUSH-PULL



Un style traditionnel caractérise la porte à cadre, réinterprétée dans une tonalité moderne, enrichie par des coupes géométriques bien définies et une polyvalence exprimée par la grande modularité.

A traditional style characterises the frame door, reinterpreted in a modern key, enriched by well-defined geometric cuts and a versatility expressed in the ample modularity.



Il canale attrezzato Easyrack gestisce il piano di lavoro in modo pratico ed impeccabile fornendo tutti gli accessori di cui abbiamo bisogno.

Le canal Easyrack équipé gère le plan de travail de manière pratique et impeccable, en fournissant tous les accessoires dont nous avons besoin.

The Easyrack equipped canal manages the worktop in a practical and impeccable way, providing all the accessories we need.



Rovere Paglia

Laminato Hpl Keope



YOUNG COLLECTION

Le giovani generazioni sono sempre alla ricerca di nuove interpretazioni dell'abitare. Attenti alle tendenze e alle mode del momento ma al contempo inclini alla semplicità, alla concretezza e alla scelta di arredi pratici e funzionali dall'elevata resa estetica.

Les jeunes générations sont toujours à la recherche de nouvelles interprétations de vie. Attentives aux tendances et aux modes mais aux même temps enclin à la simplicité, au concret et au choix de mobilier pratique et fonctionnel avec un rendu esthétique élevé.

Young generations are continuously looking for new living interpretations. Careful to trends and fashions of the moment but at the same time seeking simplicity, concreteness and the choice of practical and functional furnishings with a high aesthetic yield.



TIFFANY

SYSTEM KAPPA
GOLA



MANIGLIA

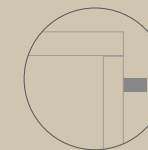

PUSH-PULL

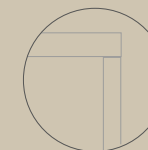

CLOÈ



FINITURE PROFILO

Finitions profil
Profile finishes



BRONZO
TITANIO



ACCIAIO
SATINATO



TIFFANY

Tiffany è una cucina trasversale che abbraccia gusti e stili di vita diversi. Materiali e finiture ne definiscono gli spazi, vivacità e modernità sono segni distintivi del suo carattere.



Tiffany est une cuisine transversale, qui embrasse des modes de vie et des goûts différents. Matériaux et finitions définissent les espaces ; vivacité et modernité sont les signes distinctifs de sa personnalité.

Tiffany is crosswise kitchen that embraces different tastes and lifestyles. Materials and finishes define spaces; liveliness and modernity are distinctive signs of its personality.



Rovere Ambra Nodato
Laccato Platino Matt
Laminato Hpl Jupiter



Melaminico Bianco Nuvola Matt
Laminato Quercia Naturale

Laccato Platino Matt
Quarzo Terrazzo Grey





CLOÈ

Semplice e giovane è la soluzione del profilo integrato che rende la presa dell'anta estremamente pratica. Contrasti e accordi di finiture permettono di dare forma a composizioni accattivanti e concrete. Finiture fresche e luminose come il laccato lucido, più tradizionali come l'effetto legno oppure di tendenza come l'effetto pietra sapranno accontentare i gusti di tutti.

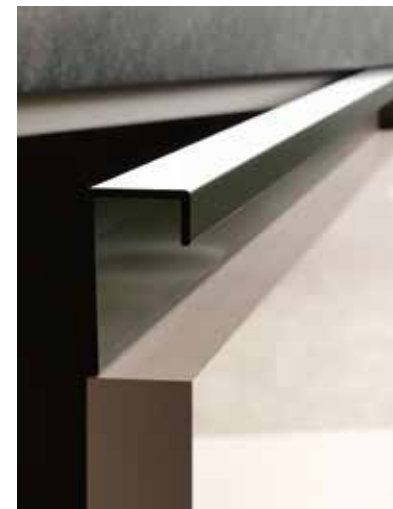

Le profil intégré est simple et jeune, ce qui rend la porte extrêmement pratique. Les contrastes des finitions permettent de donner forme à des compositions captivantes et concrètes. Des finitions fraîches et lumineuses comme la laque brillante, plus traditionnelles comme l'effet bois ou tendance comme l'effet pierre satisferont tous les goûts.

The integrated profile solution is simple and youthful, making the door extremely practical. Contrasting and matching finishes allow to give shape to captivating and concrete compositions. Fresh and bright finishes such as glossy lacquer, more traditional like the wood effect or trendy like the stone effect will satisfy everyone's tastes.



Melaminico Calce Brown

Laccato Bianco Nuvola Matt

Laminato Graniglia





POLIMERIC COLLECTION

Le cucine in polimerico, grazie alle proprietà del materiale di rivestimento, si presentano in una vasta gamma di finiture, sia opache che lucide, che spaziano da tonalità monocromatiche ad imitazioni realistiche del legno. Tantissime sono quindi le possibilità di composizioni di forme, di volumi e di abbinamenti cromatici.

Les cuisines en polymère, grâce aux propriétés du matériau de revêtement, se déclinent dans une large gamme de finitions, tant mates que brillantes, allant des teintes monochromes aux imitations réalistes du bois. Il existe donc de nombreuses possibilités de compositions de formes, de volumes et de combinaisons de couleurs.

Polymer kitchens, thanks to the properties of the coating material, come in a wide range of finishes, both matt and glossy, ranging from monochromatic shades to realistic imitations of wood. There are therefore many possibilities for compositions of shapes, volumes and colour combinations.

FINITURE PROFILO

Finitions profil
Profile finishes



BRONZO
TITANIO



ACCIAIO
SATINATO

KALEA

SYSTEM KAPPA
GOLA



MANIGLIA

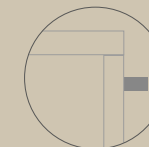

PUSH-PULL



QUADRA

SYSTEM KAPPA
GOLA



MANIGLIA

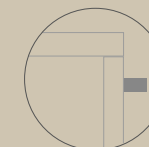

PUSH-PULL



SISTEMI DI APERTURA

Système d'ouverture
Opening system



KALEA

Kalea è una cucina dove il polimerico con le sue innumerevoli finiture, diventa reale attrattiva, per un progetto ricco di contenuti.

Kalea est une cuisine où le polymère avec ses innombrables finitions devient une véritable attraction, pour un projet riche en contenu. Kalea is a kitchen where the polymer, with its countless finishes, becomes a true attraction, for a design rich in content.

Polimerico Cemento Sabbia
Polimerico Grigio Sasso Matt
Melaminico Rovere Paglia
Quarzo Terrazzo Opaco White





QUADRA

Un legame con la tradizione che si rinsalda attraverso una nuova prospettiva e una reinterpretazione in chiave squisitamente personale.



Un lien avec la tradition qui est renforcé par une nouvelle perspective et une réinterprétation dans une touche personnelle exquise.

A bond with tradition that is strengthened through a new perspective and a reinterpretation in an exquisitely personal key.





Polimerico Grigio Carbone
Melaminico Calce Silver
Quarzo Cosmo



02

COMPLEMENTS

LA CUCINA è l'ambiente più importante di tutta la casa, luogo di incontri ed emozioni, dove anche l'estetica ha la sua importanza. I complementi che creiamo per dare vita ad un progetto più completo aiutano a rendere il tutto unico e fortemente personale.

- **BOOKSHELF**

ELECTA
ARCADIA
LOGIKA/ MINI LOGIKA

- **NETTY**

- **SKY**

- **FREE**

- **X-BACCO**

- **KREOS**

- **ARGO**

- **MODUS**

- **O- LINE**

- **NEW SERVICE**

- **TEKA**

- **YUKI**

- **SIGNE MODULI**

- **CANALI ATTREZZATI
E BARRE MULTIFUNZIONE**

La cuisine est l'espace plus important de toute la maison, un lieu de rencontre et d'émotions, où l'aspect esthétique a aussi son importance. Les compléments que nous créons pour donner vie à un projet plus complet aident à rendre l'ensemble unique et fortement personnel.

The kitchen is the most important room of the house, a place for meetings and emotions, where aesthetics has its own importance. The pieces of furniture we create to give life to a more complete project, help us to make the home unique and highly personal.

BOOKSHELF

ELECTA

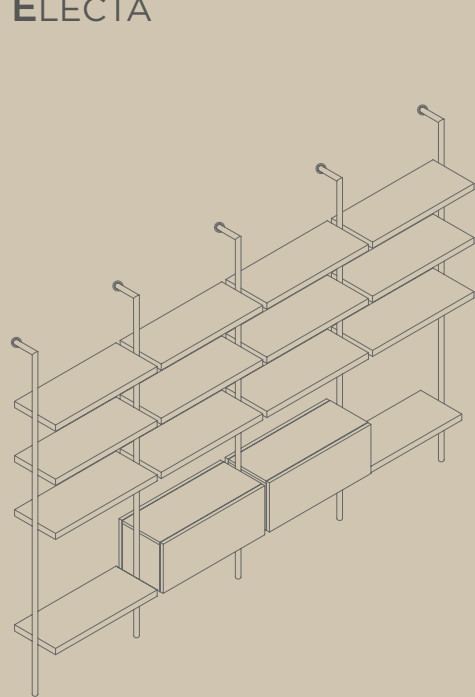

A PARETE

Mur
Wall

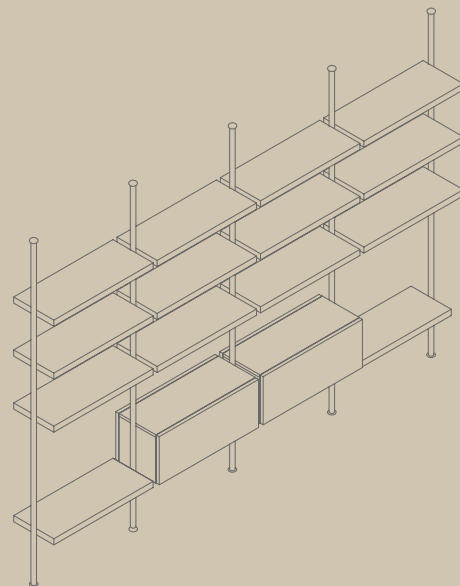

A SOFFITTO

Plafond
Ceiling

ARCADIA

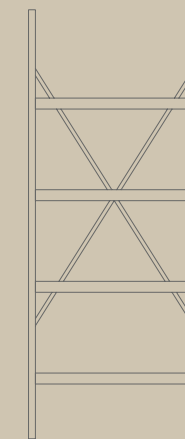
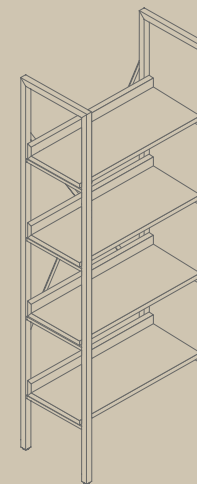

LOGIKA

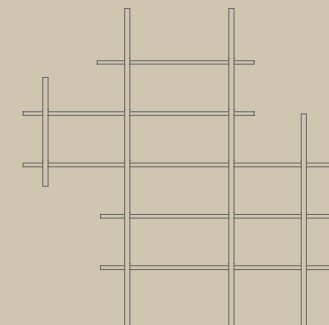
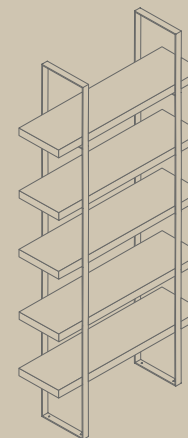



ELECTA

Un sistema libreria caratterizzato dalla libertà di scelta in altezza e di posizione degli elementi, con la possibilità di creare molteplici configurazioni libere oppure a parete.

Un système de bibliothèque caractérisé par la liberté de choix de la hauteur et de la position des éléments, avec la possibilité de créer de multiples configurations autoportantes ou murales.

A bookcase system characterised by the freedom of choice in height and position of the elements, with the possibility of creating multiple free or wall configurations.

ARCADIA

ARCADIA é una libreria composta da due telai metallici realizzati con tubi di sezione 25x25mm, collegati ed irrigiditi da controventi realizzati con profili piatti da 15x4mm. I ripiani sono realizzati in svariate finiture e possono essere di spessore 40 o 18 mm lavorati a folding. Si può utilizzare integrata con gli elementi cucina o in versione free.

ARCADIA est une librairie composée de 2 cadres métalliques fabriqués avec un tuyau de section 20x20mm, liés et figés par des contrevents réalisés avec des profils plats de 15x4mm. Les étagères sont réalisées en plusieurs finitions et elles peuvent être d'épaisseur 40mm ou 20 mm travaillées à folding. Elle est utilisable avec des éléments de cuisine ou en version libre.

ARCADIA is a bookcase composed by 2 metal frames made of tubes with a section of 20x20mm, connected and fixed by braces created with flat profiles of 15x4mm. The shelves are available in diverse finishes and they can be processed in folding with thickness of 40mm or 20mm. Arcadia can be used in combination with the kitchen elements or in free version.



LOGIKA

LOGIKA è una libreria costruita con montanti modulari sia in altezza che in larghezza. MINI LOGIKA è la sua variante sottopensile. Liberando la fantasia in cucina, reinterpreta lo spazio costruendo soluzioni adeguate alle esigenze di ognuno di noi.

Lokica est une bibliothèque composée en hauteur et en largeur par des montants modulaires. Mini Logika c'est sa version sous-meubles-hauts. Elles réinterprètent l'espace de la cuisine en libérant ainsi l'imagination en construisant des solutions adaptées aux besoins de chacun.

Logika is a bookcase built both in height and in width with modular uprights. Mini Logika is its under-wall-units version. They reinterpret the space of the kitchen and let the imagination free to build solutions fitting everyone's needs.



NETTY

NETTY è una libreria modulare, i cui alveari armonici possono essere combinati in svariati modi per posizionare e contenere oggetti. Praticità in cucina è il suo motto.

NETTY est une librairie modulaire, dont ses embrasures harmoniques peuvent être combinées de façons diverses pour positionner et ranger des objets. Pratique en cuisine est sa devise.

NETTY is a modular bookcase with harmonious beehives that may be combined in many different ways in order to position and contain objects. Practicality in the kitchen is its motto.



SKY

Sky è una mensola a parete in lamiera piegata dalle caratteristiche innovative che coniugano estetica e affidabilità. Può essere corredata di luce a led.

Sky est un support mural en tôle pliée doté de caractéristiques innovantes qui allient esthétique et fiabilité. Il peut être équipé d'une lumière LED.

Sky is a wall shelf in folded sheet metal with innovative characteristics that combine aesthetics and reliability. It can be equipped with LED lighting.



FREE

FREE è pensato come un prodotto trasversale per ogni tipo di ambiente, si fa apprezzare per la sua versatilità. Composto da montanti di alluminio, crea un deciso segno grafico che può arricchirsi con le molteplici finiture di schiene e ripiani.

FREE est conçu comme un produit transversal pour tout type d'environnement et est apprécié pour sa polyvalence. Grâce à ses montants en aluminium, crée un signe graphique valorisé par les différentes finitions du dos et des étagères.

FREE is designed as a transversal product for every kind of environment, it is appreciated for its versatility. Composed of aluminum uprights, it creates a decisive graphic sign enriched by the wide range of finishes of backs and shelves.



X- BACCO

X-BACCO, un incastro di metallo che forma degli spazi ritmati, fissato ad un pannello personalizzato dalle svariate finiture.

Un elemento di design dove esporre bottiglie sempre a portata di mano.

X-BACCO est un casier métallique qui forme des espaces rythmiques fixé à un panneau personnalisé en différentes finitions. Un élément de design qui permet de fer montre des bouteilles toujours à portée de main.

X-BACCO is a metal display that creates dynamic spaces, fixed to a panel customized in various finishes. It's a design element to display bottles always at hand.



ARGO

ARGO è una sistema di parete attrezzata, dallo schienale personalizzabile con diverse finiture e con montanti e mensole in metallo. Modulare per dimensione, porta in cucina molteplici soluzioni organizzative.

ARGO est un système mural équipé, avec un panneau mural personnalisable aux différentes finitions et aux montants et étagères en métal. Ses tailles modulaires apportent de multiples solutions d'organisation à la cuisine.

ARGO is an equipped wall-system, with a customizable wallpanel in different finishes and metal uprights and shelves. Its modular sizes bring multiple organizational solutions to the kitchen.



KREOS

KREOS è una simpatica mensola con fianchi e schiene in metallo dagli spigoli arrotondati. Posizionandola sotto il pensile diventa un pratico e utile portaspesie.

KREOS est une jolie étagère aux côtés et dos en métal, légèrement arrondie. Si on la met sous les éléments hauts elle devient une étagère à épices pratique et utile.

KREOS is a nice shelf with gently rounded metal sides and backs; by placing it under the wall units it can become a practical and useful spice rack.



MODUS

MODUS è un elemento di servizio in alluminio che si adatta alle più disparate esigenze tecniche e compositive, mantenendo sempre linearità ed uniformità estetica. Con sobrietà ed eleganza arricchisce le composizioni a parete e ad isola.

MODUS est un conteneur en aluminium qui s'adapte aux exigences techniques et de composition les plus différentes tout en maintenant une linéarité et une uniformité esthétique. Modus peut enrichir les compositions en îlots et les linéaires murs avec sobriété et élégance.

MODUS is an aluminium container that fits to the most varied technical and compositional needs while keeping linearity and aesthetic uniformity. Modus can enrich island and wall compositions with sobriety and elegance.



O-LINE

O-LINE è una boiserie caratterizzata da un elemento in metallo rettangolare che rompe la simmetria dello spazio e delle mensole. Offre la possibilità di tenere tutti gli oggetti di uso quotidiano sempre a portata di mano, conferendo alla cucina un aspetto personale.

O-LINE est une boiserie caractérisée par un élément métallique rectangulaire qui brise la symétrie de l'espace et des étagères. Il offre la possibilité de garder tous les objets du quotidien à portée de main, donnant à la cuisine une apparence personnelle.

O-LINE is characterized by a rectangular metal element that breaks the symmetry of space and shelves. It offers the possibility of keeping everyday objects always at hand, giving the kitchen a personal appearance.

NEW SERVICE

Elemento corredato di luce che ottimizza gli spazi contenendo le spezie, i barattoli e quant'altro sia utile avere a portata di mano.

Un élément lumineux qui optimise l'espace en rangeant les épices, les bocaux et tout ce qui est utile d'avoir à portée de main.

Element equipped with lighting that optimises the spaces containing spices, jars and anything else that one would like close at hand.





TEKA

TEKA è un terminale per pensile e colonne con un carattere ben definito. Un montante in metallo dal segno distintivo supporta i ripiani. La variante con schiena luminosa crea sofisticati e gradevoli effetti di luce.

TEKA est un élément terminale pour meubles hauts et armoires avec une personnalité définie. Un montant métallique soutient les étagères et donne caractère; la variante à dos lumineux crée des effets de lumière sophistiqués et agréables.

TEKA is an end element for wall- units and tall-units with a well-defined personality. A metal bar supports the shelves and gives character; the version with luminous back creates sophisticated and pleasing light effects.



YUKI

Una colonna a giorno dotata di cassettoni e ripiani dove l'elemento distintivo è un segno verticale in metallo, una linea di luce che valorizza gli oggetti esposti.

Une colonne ouverte avec des tiroirs et des étagères où l'élément distinctif est un signe vertical en métal, une ligne de lumière qui met en valeur les objets exposés.

An open tall unit equipped with small drawers and shelves where the distinctive element is a metal vertical sign, a line of light that enhances the objects on display.



SIGNE MODULI

L'ampia serie di accessori proposti, i moduli a giorno componibili, le mensole e i porta oggetti, rendono Signe adatto ad ogni ambiente domestico.

La vaste gamme d'accessoires proposés, les modules ouverts modulaires, les étagères et les unités de rangement permettent à Signe de s'adapter à tout environnement domestique.

The wide range of accessories proposed, the modular open modules, the shelves and object holders, make Signe suitable for every home environment.

VERTICALI

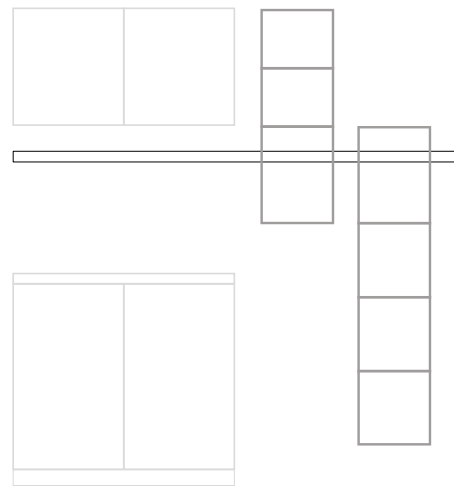

MODULI

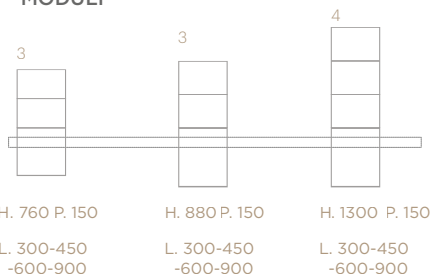

ORIZZONTALI

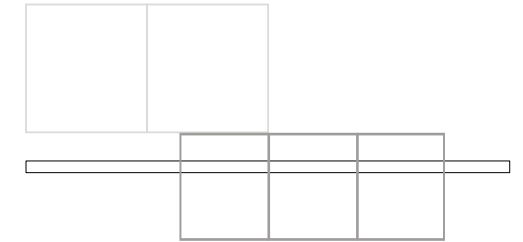

MODULI

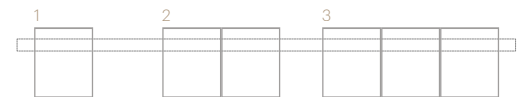

H. 400	H. 400	H. 400
P. 150	P. 150	P. 150
L. 300-450 -600	L. 900	L. 1200

CANALI ATTREZZATI BARRE MULTIFUNZIONE

Zecchinon propone una serie completa di accessori funzionali e dal design evoluto, ideati per migliorare l'operatività in cucina.

Portaprese elettriche per elettrificare i piani cucina senza rinunciare alla pulizia e un'ampia scelta di accessori per lavelli e per la zona cottura.

CANAUX ÉQUIPÉS BARRES MULTIFONCTIONS

Zecchinon propose une gamme complète d'accessoires fonctionnels au design avancé, conçus pour améliorer l'opérabilité dans la cuisine. Des prises électriques pour électrifier les plans de travail sans sacrifier la propreté et une large gamme d'accessoires pour les éviers et la zone de cuisson.

EQUIPPED CANALS MULTIFUNCTION BARS

Zecchinon offers a complete series of functional accessories with an advanced design, created with ease of operation in the kitchen in mind. Electric socket holders to supply power to kitchen countertops without sacrificing the clean look and a wide choice of accessories for sinks and for the cooking area.

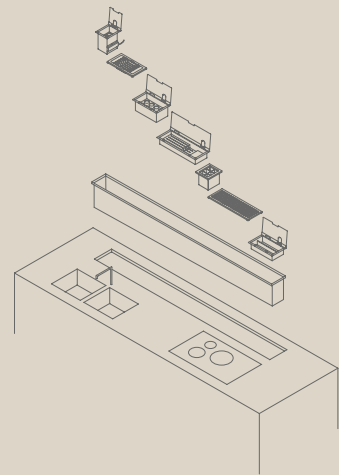

EASYRACK

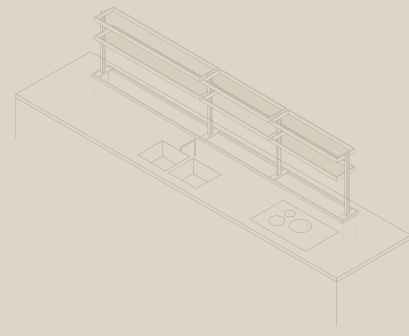

EASYSHELF

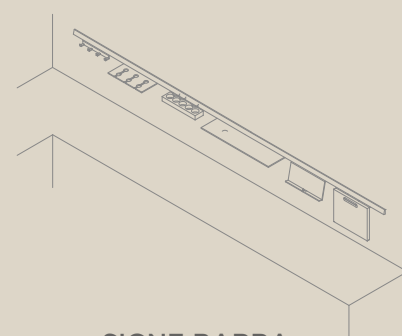

SIGNE BARRA
ATTREZZATA



EASYRACK

Utile ed innovativo canale attrezzato; un'idea elegante e pratica per personalizzare il piano di lavoro.

Canal équipé utile et innovant ; une idée élégante et pratique pour personnaliser le plan de travail.

Useful and innovative equipped canal; an elegant and practical idea for customising the worktop.



EASYSHELF

Sistema di ripiani dotati di luce, realizzato per essere applicato sui canali attrezzati Easyrack.

Système d'étagères avec lumière, conçu pour être appliqué sur des canaux équipés Easyrack.

System of shelves equipped with lighting, designed to be applied on Easyrack equipped canals.



SIGNE BARRA ATTREZZATA

Profilo in alluminio anodizzato nero, che può essere integrato con una serie di accessori che contribuiscono ad arredare e dare servizio in cucina.

Profilé en aluminium anodisé noir, qui peut être complété par une série d'accessoires qui contribuent à l'aménagement et au service de la cuisine.

Black anodised aluminium profile, which can be supplemented with a series of accessories that help to furnish and provide service in the kitchen.

03

ATTREZZARE ED ORGANIZZARE

- ATTREZZATURE INTERNE
- ILLUMINAZIONE
- RACCOLTA DIFFERENZIATA

Per rendere la cucina un luogo di benessere occorre curarla in ogni suo aspetto. Bellezza e funzione devono essere in perfetta armonia, è necessario conoscere le esigenze delle persone, effettuare una continua ricerca sui materiali e sulle tecnologie, studiare a fondo gli usi ed i costumi di un mondo in continua evoluzione. Questo perchè le nostre cucine siano sempre in grado di superare le influenze volubili delle mode.

Équiper et organiser_Pour rendre la cuisine un lieu de bien-être il faut prendre soin de chaque aspect. La beauté et la fonction doivent être en parfaite harmonie, il est nécessaire reconnaître les exigences des personnes, effectuer une recherche continue des matériaux et des technologies, étudier à fond les coutumes et les traditions d'un monde en pleine évolution. Ceci parce que nos cuisines doivent être en gré de dépasser les influences volubiles des modes.

Fitting and organising_It is necessary to take care of every aspect of the kitchen to make it become a place of wellness. Beauty and functionality must be in complete harmony and it is essential to be aware of peoples' needs, to carry out continuous research on materials and technologies, to fully explore habits and traditions of a world that is constantly evolving. All this because our kitchens must always be able to overcome fashion changing influences.



QUALITÀ GARANTITA

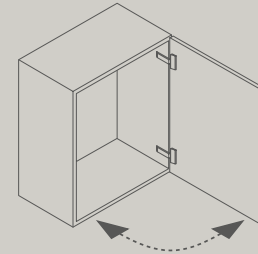

80.000 cicli di apertura e chiusura, normativa Portata massima fino a 70kg Spessore anta 22mm europea Uni EN 15570

QUALITÉ GARANTIE 80 000 cycles d'ouverture et de fermeture, charge maximale jusqu'à 70 kg. Portes épaisseur 22 mm, norme européenne Uni EN 15570

QUALITY GUARANTEED 80,000 opening and closing cycles, maximum load up to 70kg, 22 mm thick doors, European Standard Uni EN 15570

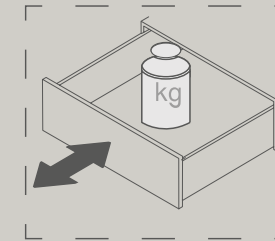

100.000 movimenti di apertura e chiusura, di cui 30.000 movimenti di apertura totale fino al fermo a finecorsa. PORTATA MASSIMA FINO A 70 KG

100 000 mouvements d'ouverture et de fermeture, dont 30 000 mouvements d'ouverture totale jusqu'à arrêt au fin de course PORTÉ MAXIMALE JUSQU'À 70 KG

100,000 opening and closing movements, of which 30,000 total opening movements up to stop at limit switch MAXIMUM LOAD UP TO 70 KG

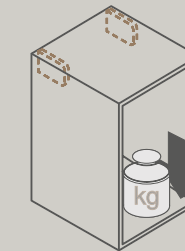

PORTATA MASSIMA FINO A 70 KG

**PORTÉE MAXIMALE JUSQU'À 70KG
MAXIMUM LOAD UP TO 70 KG**

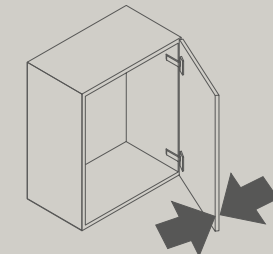

SPESSORE ANTA 22MM

**PORTES ÉPAISSEUR 22MM
22 MM THICK DOORS**



ANTE AMMORTIZZATE

Portes amorties
Soft closing doors



MECCANISMI TOP QUALITY

Mécanismes Top Quality
Top Quality mechanisms



CARICO DI RESISTENZA 70 KG

PORTÉE 70 KG
MAXIMUM LOAD UP TO 70 KG



STRUTTURE ROBUSTE spessore anta 22

L'éclairage est le composant émotionnel d'un environnement.
Strong carcasses - 22mm thick doors

ATTREZZATURE INTERNE

Comodità, ordine, ergonomia.

La composizione di una buona cucina richiede scelte attente e mirate, in risposta alle diverse esigenze che derivano anche dal carattere, dall'età, dai programmi di vita del cliente. L'assoluta funzionalità dei singoli complementi, l'alto livello tecnologico di ogni elemento, l'efficienza e l'affidabilità di ogni singola attrezzatura qualificano e rendono unico questo importante ambiente della casa.

Confort, ordre, ergonomie. La composition d'une bonne cuisine exige des choix attentifs et visés, pour répondre aux exigences diverses qui proviennent aussi du caractère, de l'âge, des programmes de vie du client. La grande fonctionnalité de chaque complément, le haut niveau technologique de chaque élément, l'efficacité et la fiabilité de chaque équipement qualifient et rendent unique cet important milieu de la maison.

Comfort, order, ergonomics. The composition of a nice kitchen requires careful and targeted choices as the answer to different needs deriving also from the customer character, age and life plans. The absolute functionality of the single pieces of furniture, the high level of technology of every element, the efficiency and reliability of each equipment, qualify and make unique this important space of the house.



ATTREZZARE LE BASI

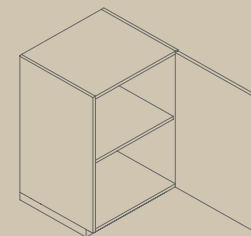

BASE ANTA BATTENTE CON RIPIANI

Meuble bas avec porte battante et étagères

Hinged door base units with shelves

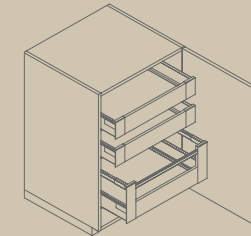

BASE ANTA BATTENTE CON CASSETTI E CESTI INTERNI

Porte battante + Tiroirs et paniers internes

Hinged door + Internal drawers and baskets

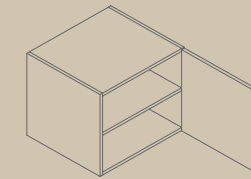

BASE SOSPESA CON RIPIANI

Meuble bas suspendu avec étagères

Hanging base unit with shelves

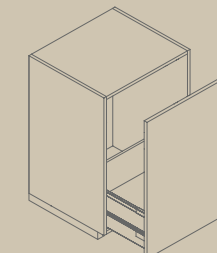

ANTA ESTRAIBILE

Porte amovible
Extractable door

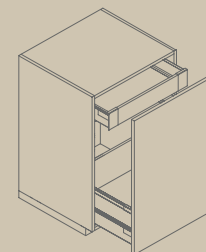

ANTA ESTRAIBILE +CASSETTO INTERNO

Porte amovibile + Tiroirs internes
Extractable door+ Internal drawers

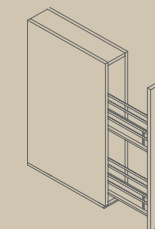

ANTA ESTRAIBILE +PORTABOTTIGLIE

Porte extractible et range bouteilles
Pull-out base unit and bottle holder

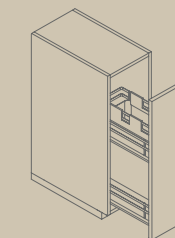

ANTA ESTRAIBILE + PORTAPANE

Porte extractible et sac à pain
Pull-out base unit and bread holder

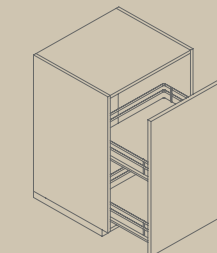

ANTA ESTRAIBILE + CESTELLO

Porte extractible et panier
Pull-out base unit and basket

ANTA BATTENTE

Meubles bas avec porte battante
Hinged door base units



ANTA ESTRAIBILE

Jeunes solutions passionnées.
Passionate young solutions.

CASSETTI E CESTONI

Tiroirs et casseroles
Drawers and deep drawers

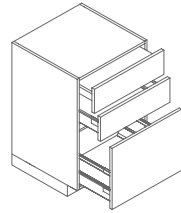

2 CASSETTI + 1 CESTONE
2 Tiroirs + 1 Paniers
2 Drawers + 1 Large baskets

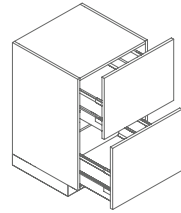

2 CESTONI
Paniers
Large baskets

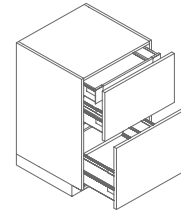

2 CESTONI + CASSETTO INTERNO
Paniers + Tiroirs interni
Large baskets + Internal drawers



BASI AD ANGOLO

Bas d'angle
Corner base units

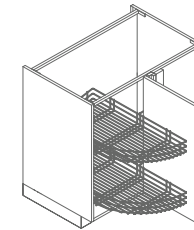

BASE AD ANGOLO CON CESTI MEZZELUNE
Bas d'angle avec paniers pivotants
Corner base units with revolving baskets

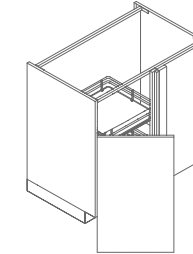

BASE AD ANGOLO CON MECCANISMO ESTRAIBILE MAGIC CORNER
Bas d'angle avec Magic Corner
Corner base unit with Magic Corner

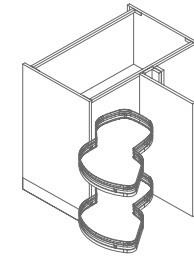

BASE AD ANGOLO CON MECCANISMO FAGIOLO/NUVOLA ESTRAIBILE
Bas d'angle avec mécanisme extractible Fagiolo - Nuvola
Corner base unit with Fagiolo - Nuvola pullout mechanism

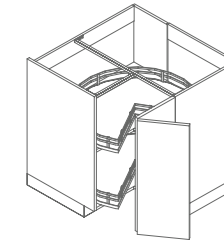

BASE AD ANGOLO "L" CON CESTELLI PIVOT
Bas d'angle en "L" avec paniers pivotants
Corner base unit with revolving baskets



ATTREZZATURE COLONNE E SEMICOLONNE

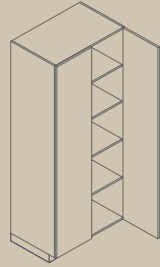

**COLONNA ANTE
BATTENTI CON RIPIANI**

Armoire porte battante
avec étagères

Tall unit with hinged
door and shelves

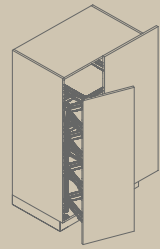

**SEMICOLONNA CON
MECCANISMO MAGIC CORNER**

Demi armoire avec mécanisme
Magic Corner

Tall unit with Magic Corner
mechanism

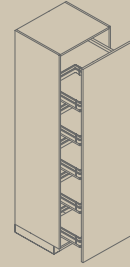

**COLONNA ESTRAIBILE
CON MECCANISMO 255**

Armoire extractible avec
mécanisme 255

Pullout tall unit with 255
mechanism

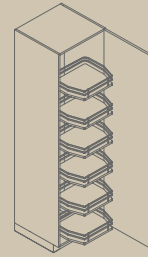

**COLONNA ANTA
BATTENTE CON
MECCANISMO 295**

Armoire porte battante avec
mécanisme 295

Tall unit with hinged door with
295 mechanism

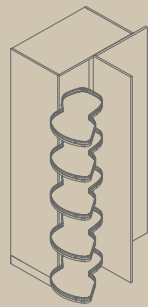

**COLONNA ANGOLO
CON MECCANISMO
FAGIOLO**

Armoire avec mécanisme
Fagiolo

Tall unit with Fagiolo
mechanism

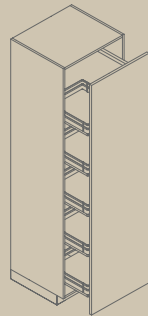

**COLONNA ESTRAIBILE CON
MECCANISMO DISPENSA
90°**

Armoire extractible avec
mécanisme DISPENSA 90°

Pullout tall unit with DISPENSA
90° mechanism

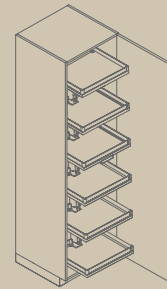

**COLONNA ANTA BATTENTE
CON MECCANISMO LAVIDO
/ TANDEM SOLO**

Armoire avec mécanisme
LAVIDO/TANDEM SOLO

Tall unit with LAVIDO/TANDEM
SOLO mechanism



SISTEMI DI ORGANIZZAZIONE

Systèmes d'organisation
Organization systems



ANTARO

ATTREZZATURA PER CASSETTI E CESTI

Progettare una cucina bella, pratica, personale e conviviale è più facile utilizzando le innumerevoli soluzioni funzionali che sono possibili grazie ai sistemi Antaro.

Équiper les tiroirs et les paniers. Concevoir une belle cuisine, pratique, personnelle et conviviale est plus facile si on utilise les nombreuses solutions fonctionnelles qui sont possibles grâce aux systèmes Antaro.

How to equip drawers and large baskets
Designing a beautiful, practical, personal and convivial kitchen is easier if using the numerous functional solutions that are possible thanks to Antaro systems.

GRIGIO ORIONE



BIANCO



LEGRABOX

ATTREZZATURA PER CASSETTI E CESTI

Il sistema di guide per cassetti Legrabox coniuga un design sobrio ad progresso più avanzato in fatto di funzionalità.

Équipement legrabox pour tiroirs et casseroles
Le système de glissière pour tiroirs Legrabox offre un design sobre et le progrès les plus avancé en termes de fonctionnalité.

Legrabox equipment for drawers and deep drawers
The Legrabox drawers runner system combines sober design with most advanced progress in terms of functionality.

GRIGIO ORIONE



BIANCO



ACCESSORI PER LEGRABOX

Accessoires pour Legrabox.
Accessories for Legrabox.

AMBIA LINE

PORTAPOSATE

Il sistema di suddivisione interna AMBIA-LINE si contraddistingue per le versatili possibilità di utilizzo: i telai dall'impiego trasversale sono coordinabili con il sistema box LEGRABOX e permettono un perfetto ordine in cucina.

AMBIA LINE - PORTE-COUVERTS Le système de cloisons AMBIA-LINE se caractérise par de larges possibilités d'utilisation: les cadres à usage transversal peuvent être coordonnés avec le système de caissons LEGRABOX et permettent un ordre parfait dans la cuisine.

AMBIA LINE - CUTLERY HOLDER The AMBIA-LINE internal partition system is characterized by wide possibilities of use: the frames with transversal use can be coordinated with the LEGRABOX box system and allow perfect tidiness in the kitchen.



FINITURE IN METALLO VERNICIATO

Finitions en métal verni
Painted metal finish

GRIGIO
ORIONE

BIANCO

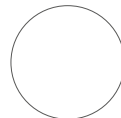

POLIPROPILENE

Polypropylène
Polypropylene



Immagine a lato: sistema di suddivisione interna (portaposate) per LEGRABOX in polipropilene.

Image à côté: système de division interne (range couverts) pour Legrabox en polypropylène.

Image on the side: internal division system (cutlery tray) in polypropylene for Legrabox.

ATTEZZATURE INTERNE

I pratici accessori in cucina ambia-line uniscono un design elegante a un funzionamento impeccabile che fornisce al cliente un'esperienza completa nell'utilizzo della cucina.

Les accessoires ambia-line, très pratiques, combinent un design élégant avec un fonctionnement sans faille qui offre au client une expérience complète dans l'utilisation de la cuisine.

The practical ambia-line accessories combine elegant design with flawless operation that provides the customer a complete experience in using the kitchen.



PORTAPELLICOLE

Porte papiers
Cling film holder



PORTAPELLICOLE

Porte papiers
Cling film holder

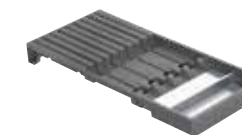

PORTACOLTELLI

Porte couteaux
Knife holder



PORTASPEZIE

Porte épices
Spice holder



PORTAPIATTI

Porte assiettes
Plate holder



DIVISORIO INTERNO

Cloison interne
Internal partition

ACCESSORI PER LEGRABOX

Systèmes d'organisation
Organization systems

NOMAD

I vari elementi che compongono il programma NOMAD in massello di frassino nero possono essere combinati liberamente all'interno del cassetto.

L'ordre avec une touche de design! Les différents éléments qui composent le programme NOMAD bord en frêne noir peuvent être associés librement à l'intérieur du tiroir.

Tidiness with a touch of design! All the elements that compose NOMAD made of black solid ash wood may be freely combined inside the drawer.

ROVERE GRIGIO

Chêne gris
Grey oak



PORTACOLTELLI

Porte couteaux
Knife holder

MODULI POSATE

Module couverts
Cutlery module

SET PORTACOPERCHI

Série porte couvercles
Lid holder set

PORTAPPELLICOLE

Porte papiers
Cling film holder



PORTASPEZIE

Porte épices
Spice holder



TAGLIERE

Planche à découper
Cutting board



FONDO DISPENSA + PILASTRINI+ SET GRIP

Buffet de cuisine + série grip ou pilastre
Larder + grip or small pillar set



SISTEMI DI APERTURA PENSILI

OUVERTURE ÉLÉMENTS
OPENINGS FOR WALL UNITS

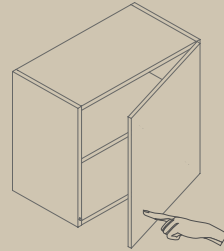

PUSH-PULL

Push-pull
Push-pull
H: 50/63,5/73/100/129,5

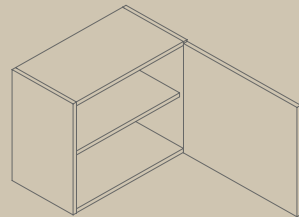

**BATTENTE CON GOLA
O MANIGLIA**

Battente avec gorge et poignée
Hinged door with groove
H: 50/ 63,5/73/100/129,5

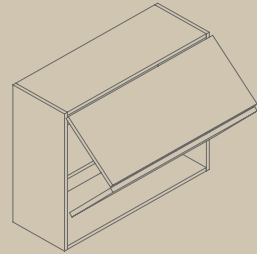

SOFFIETTO

Ouverture pliante
Folding doors
H: 73

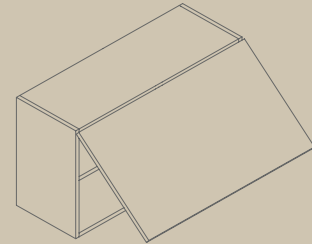

**RIBALTA
VERSO L'ALTO**

Ouverture relevable
Flap door
H: 27/36,5/ 50/ 63,5

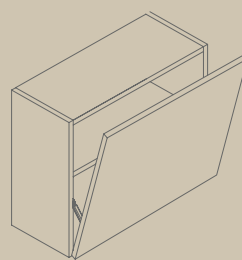

**RIBALTA VERSO
IL BASSO**

Ouverture abattante
Drop-down door
H: 27/ 36,5/ 50

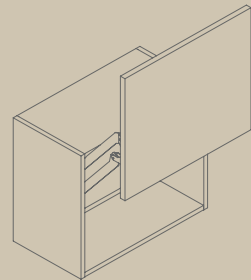

VERTICALE

Ouverture verticale
Vertical door
H: 50

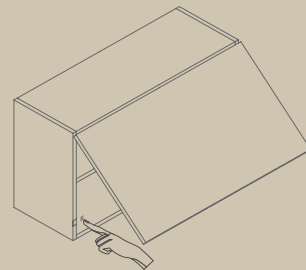

**APERTURA
ELETTRICA**

Fermetures électriques
Electric fastenings

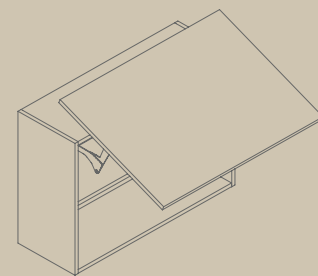

OBLIQUA

Ouverture oblique
Slanting door
H: 63,5





ILLUMINAZIONE

Soluzioni illuminotecniche, studiate per pensili, basi, colonne ed interno cassetti nate per consentire una visibilità dei contenuti. Originali barre led che oltre a dare un ottimo servizio, garantiscono un risparmio energetico.

Illumination. Des solutions techniques pour l'éclairage pour des éléments de cuisine, des bases, des colonnes et la partie interne des tiroirs, permettent une visibilité des contenus. Des barres led originales qui en plus de donner un excellent service, garantissent aussi une épargne énergétique.

Lightning. Lighting solutions designed for wall units, bases, columns and drawer interior and developed for a full visibility of the contents. Original led bars that guarantee a great lighting service as well as energy saving.

K CONCEPT

Pannello luminoso che, utilizzato come schienale, consente di illuminare in modo confortevole il piano di lavoro. La linea di accessori dedicata, comprensiva di mensole, ganci, porta rotoli e prese elettriche, consente di organizzare al meglio lo spazio di lavoro.

Panneau lumineux qui, lorsqu'il est utilisé comme dossier, permet d'éclairer confortablement le plan de travail. La gamme d'accessoires dédiée, comprenant des étagères, des crochets, des porte-rouleaux et des prises électriques, vous permet d'organiser votre espace de travail de la meilleure façon possible.

Light panel that, used as backing, allows you to comfortably illuminate the worktop. The dedicated line of accessories, including shelves, hooks, paper roll holders and electrical outlets, allows you to better organise your work space.

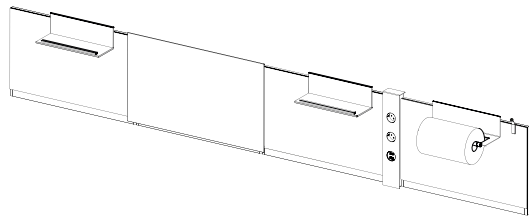

K PANEL

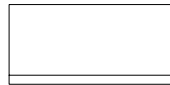
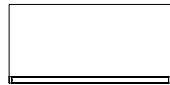

K FIRE PROTECTOR

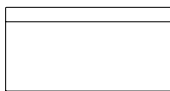

K SOCKET



K BRACKET



K ROLL HOLDER



K METAL SHELF

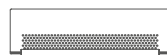

K GLASS SHELF



SIRENUSE

Profilo lineare in alluminio e policarbonato, adatto per il montaggio sul retro della mensola.

Profilé linéaire en aluminium et polycarbonate, adapté pour être monté au dos de l'étagère

Linear profile in aluminium and polycarbonate, suitable for mounting on the back of the shelf



MINI NOOR

Luce led da incasso dal design elegante e compatto.

Kaleo - éclairage - Éclairage intégré à LED au design élégant et compact.

Kaleo - lighting - Integrated LED lighting with an elegant and compact design.



OSAKA

Profilo lineare sottopensile con ottica inclinata che permette l'emissione di luce diffusa ed omogenea sul piano di lavoro.

Lugano - éclairage - Profil linéaire sous meuble haut avec optique inclinée qui permet d'avoir une lumière diffuse et homogène sur le plan de travail.

Lugano - lighting - Linear under wall units profile with inclined optic which allows to have a diffused and homogeneous light on the worktop.



BALI

Bali è un profilo lineare in alluminio anodizzato discreto e versatile, adatto per l'installazione sotto il scolapiatti.

BALI. Bali est un profil linéaire discret et polyvalent en aluminium anodisé, adapté à une installation sous le meuble haut à vaisselle.

Bali is a discreet and versatile linear profile in anodized aluminum, suitable for installation under the draining wall unit



NUBE

Faretto da incasso in alluminio con diffusore in policarbonato opalino per sottopensile.

NUBE ÉCLAIRAGE. Spot intégré en aluminium avec diffuseur en polycarbonate opalin

NUBE LIGHTING. Integrated wall unit aluminium spotlight with opal polycarbonate diffuser



KITON

Kiton è un profilo lineare con emissione luminosa diretta adatta ad illuminare l'interno dei cassetti.

KITON est un profil linéaire à émission de lumière directe adapté pour éclairer l'intérieur des tiroirs

KITON is a linear profile with direct light emission suitable for illuminating the inside of the drawers

PARIS

Pannello lineare a Led per fondopensile.

PARIS Panneau LED linéaire pour fond de meuble haut

PARIS Linear Led panel for wall unit bottom



MALINDI

Lampada LED ad alta efficienza luminosa da incasso, totale o parziale, adatta per mensole ed elementi sottopensile dell'ambiente cucina. È dotata di un'elevata luminosità a fronte di un significativo risparmio energetico.

MALINDI. Lampe LED à haute efficacité lumineuse, totale ou partielle, adaptée aux étagères et aux éléments hauts. Il offre une luminosité élevée et une économie d'énergie importante.

MALINDI. High luminous efficiency LED lamp, full- or partial length, suitable for shelves and wall units. It provides high brightness and a significant energy saving.



RACCOLTA DIFFERENZIATA

Tutto si scompone e si ricompone come un puzzle. Le pattumiere per la raccolta differenziata offrono notevoli servizi, praticità assoluta di utilizzo, ottimizzazione degli spazi che testimoniano l'attenzione di Zecchinon per l'ambiente, per tutte quelle possibili soluzioni che si traducono in suggerimenti per un'alta qualità della vita in cucina.

COLLECTE SÉPARÉE DES DÉCHETS
Le tout se décompose et compose comme un puzzle. Les poubelles pour la collecte des déchets offrent de nombreux services, une pratique absolue d'utilisation, une optimisation des espaces qui témoignent l'attention de Zecchinon pour l'environnement, pour toutes ces possibles solutions qui se traduisent par des suggestions pour une haute qualité de la vie en cuisine.

SEPARATE WASTE COLLECTION
Everything may be assembled and disassembled like a puzzle. The rubbish bins for differentiated waste collection offer remarkable services, absolute practicality of use and space optimisation: they prove Zecchinon attention for the environment, concerning all possible solutions that translate into suggestions for a high quality of life in the kitchen.

ECO FRIENDLY

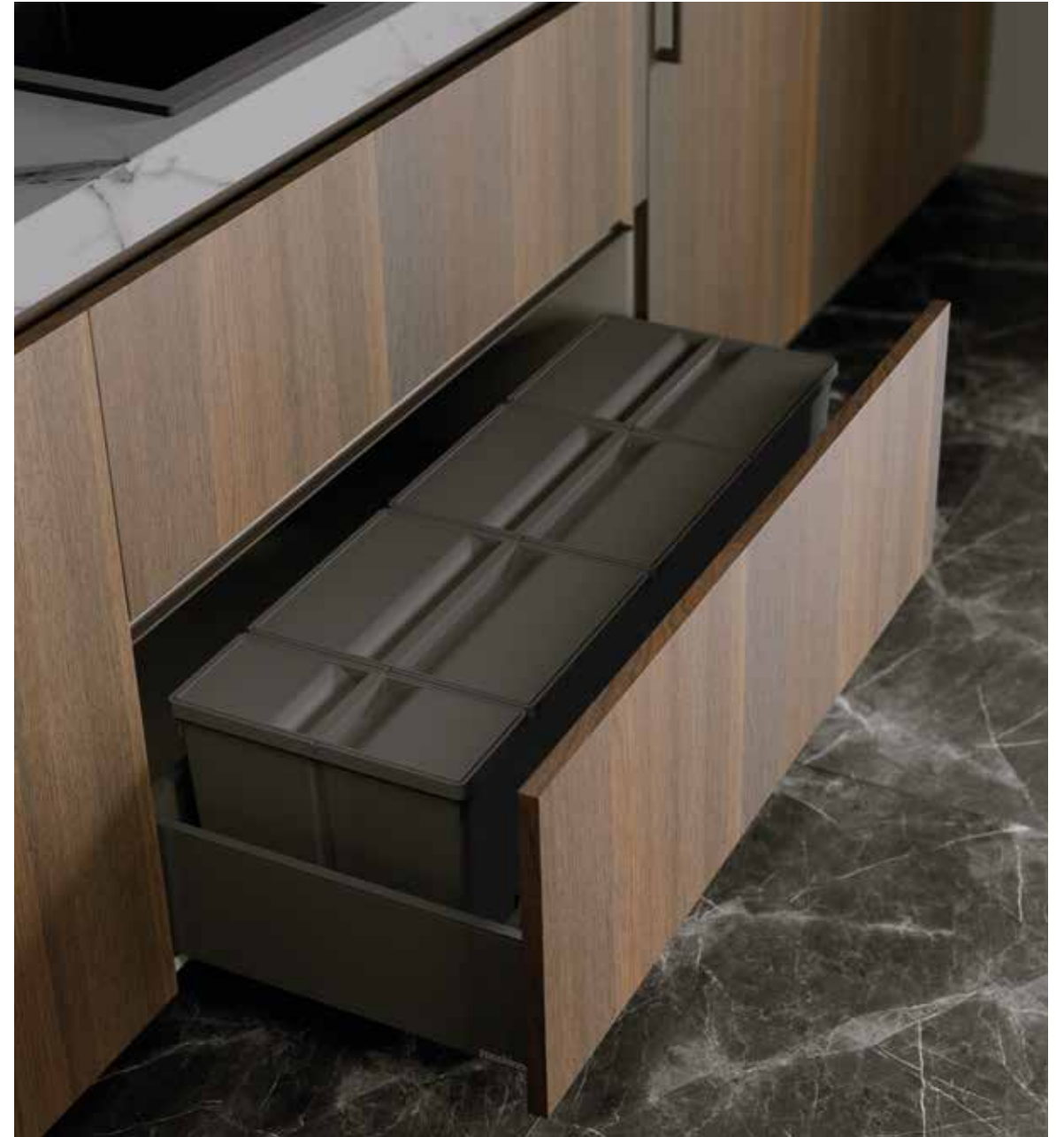
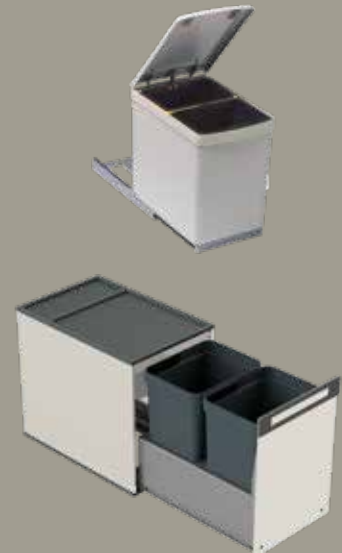

04

TAVOLI ESTRAIBILI / TAVOLI

È importante completare l'ambiente cucina con **tavoli dalle forme e dalle funzioni personalizzate** secondo i diversi modi di vivere, usando materiali e supporti abbinati a tutta la cucina.

- TAVOLI ESTRAIBILI
- TAVOLI

C'est important com-pléter l'ambiance de la cuisine avec des tables et des snacks dans des formes et des fonctions personnalisées selon les diverses façons de vivre, utilisant des matériaux et des supports associés à toute la cuisine.

It is important to complete the kitchen with tables and snacks that are customised in shapes and functions, according to the different ways of living, and using materials and supports coordinated with the whole kitchen.

TAVOLI ESTRAIBILI

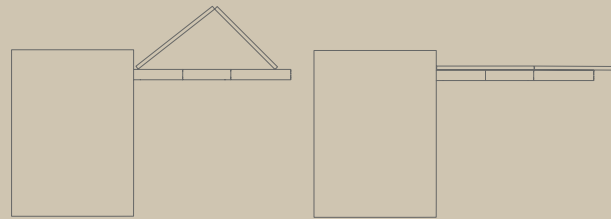

LUNCH

L.60 - 90 - 120 cm
P. 90 cm

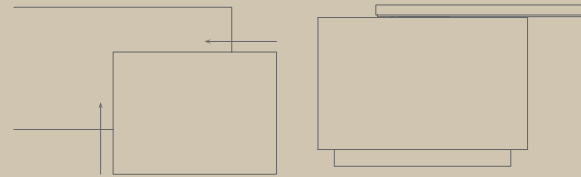

SLIDE

L.120x96 cm
P. 30 cm

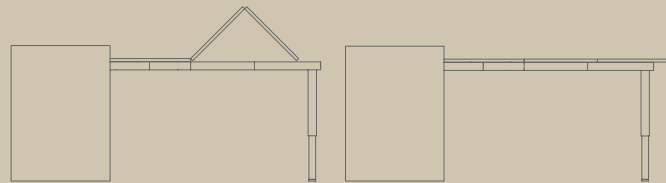

PARTY

L.60 - 90 - 120 cm
P. 138 cm

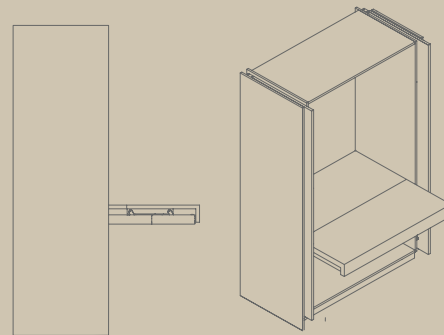

OPLÀ

L.60 - 120 cm
P. 50 cm



OPLÀ

Tavolo estraibile filo ripiano

Oplà - table extractible
Oplà - pull-out table



LUNCH

Sistema che permette l'estrazione di un tavolo a penisola da un vano che normalmente viene utilizzato per l'alloggiamento di un cassetto.

Système qui permet d'extraire une table péninsulaire d'un compartiment qui sert normalement à loger un tiroir.

System that allows the extraction of a peninsula table from a compartment that is normally used for the housing of a drawer.



PARTY

Tavolo con doppia gamba estraibile dal cassetto

Table extractible avec jambage
Pull-out table with leg



SLIDE

Piano scorrevole sopra top con movimento dritto e diagonale

Plan avec mécanisme d'ouverture linéaire ou oblique
Top with linear or diagonal opening mechanism



TAVOLI

CLUB

Ø 130 cm H. 76 cm
L. 160 - 180 - 200 cm P. 90 cm

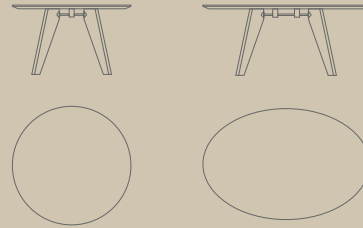

KLEIM

H. 75 cm L. 238 cm P. 112 cm

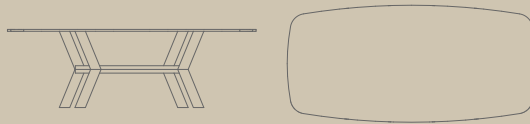

SKYLINE

H. 75 cm
L. 130 - 160 - 180 - 210 - 240 cm P. 90 cm
L. 138 cm P. 138 cm

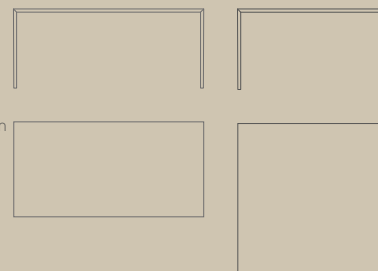

GIOVE

H. 76,2 cm
L. 140 - 160 - 180 cm P. 90 cm

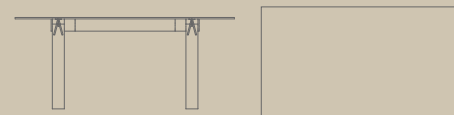

SLIM

H. 77 cm
L. 120 - 140 - 160 cm P. 80 cm
+ 60 cm L. 180 - 200 - 220 cm

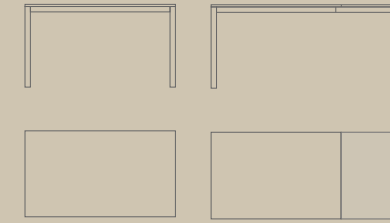

ZEUS

H. 77 cm
P. 90 cm
L. 90+60 = 120
L. 120+50+50 = 170/220
L. 140+50+50 = 190/240
L. 160+50+50 = 210/260

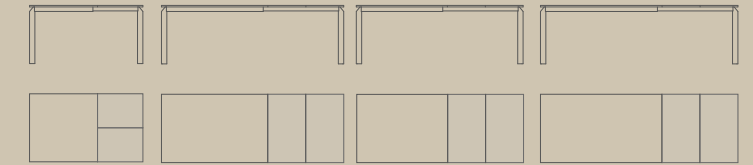

LODGE

H. 77 cm
L. 180 / 210 / 240 cm P. 100 cm
L. 160 x 160

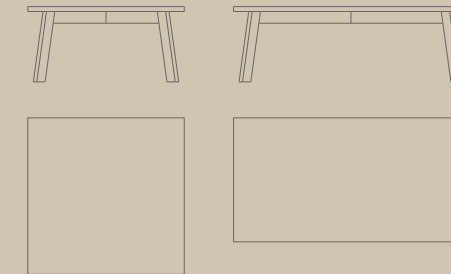

KRYOS

H. 76 cm
L. 160 / 180 / 200 cm P. 90 cm



B-LAME

H. 76 cm
L. 160 / 180 / 200 cm P. 90 cm

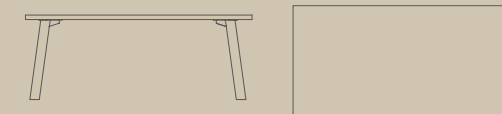

CLUB

Un tavolo rotondo e ovale disponibile nelle essenze olmo-noce o rovere, finiture legate ad una scelta stilistica ben precisa che può essere arricchita dal dettaglio del vassoio girevole, una variante che definisce un'estetica più individuale, all'insegna di materiali che comunicano un'idea di lusso.

Une table ronde et ovale disponible en orme, noyer ou chêne, finitions liées à un choix stylistique très précis qui peut être enrichi par le détail du plateau tournant, une variante qui définit une esthétique plus individuelle au nom des matériaux qui communiquent un idée de luxe.

A round and oval table available in elm, walnut or oak, finishes connected to a precise stylistic choice that can be enriched by the detail of the revolving tray, a variant that defines a more individual aesthetic in the name of materials that communicate a idea of luxury.



KLEIM

Un tavolo prezioso dallo spirito artistico, con un basamento articolato da un gioco di equilibri, un percorso che porta da un elemento all'altro suggerendo dinamismo. L'ovalità del piano addolcisce il tutto con una forte personalità.

Une table précieuse à l'esprit artistique, avec une base articulé pour un jeu d'équilibres, un chemin qui mène d'un élément à un autre suggérant du dynamisme. L'ovalité du plan adoucit tout avec une forte personnalité.

A precious table with an artistic spirit, with a base articulated by a game of balances, a path that leads from one element to another suggesting dynamism. The ovality of the plan softens everything though keeping a strong personality.



Il rovere tavolato è il legno protagonista in questo tavolo dalla presenza importante, la cui struttura si contraddistingue per il suo disegno incrociato che crea un aspetto di elegante solidità.

Le chêne Tavolato est le bois qui joue le rôle principal dans cette table, dont la structure est caractérisée par son design croisé qui crée un look de solidité élégante

Tavolato oak is the wood that plays a leading role in this table, whose structure is characterized by its crossed design that creates an appearance of elegant solidity.



SKYLINE

Leggerezza ed essenzialità sono racchiuse in questo tavolo, che con la sua struttura metallica e le sue molteplici misure assume un carattere versatile.

La légèreté et l'essence sont enfermées dans cette table qui, avec sa structure métallique et ses multiples mesures, prend un caractère polyvalent.

Lightness and essentiality are enclosed in this table, which with its metal structure and its multiple measures assumes a versatile character.



GIOVE

Leggerezza ed essenzialità sono racchiuse in questo tavolo, che con la sua struttura metallica e le sue molteplici misure assume un carattere versatile.

La structure se caractérise par des tissages géométriques légers qui soutiennent le plateau en verre trempé, donnant à la table solidité, stabilité et en même temps une grande adaptabilité stylistique et esthétique dans le monde de la maison.

The structure is featured by light geometric weaves that support the tempered glass top, giving the table solidity, stability and at the same time a high stylistic and aesthetic adaptability in the home context.



SLIM

Slim è un tavolo allungabile dalle linee moderne ed essenziali, disponibile in tre varianti di misura che lo rendono in grado di adattarsi ad ogni tipo di spazio. Il suo punto di forza è la possibilità di declinare il piano in molteplici finiture per soddisfare tutti i gusti.

Slim est une table extensible aux lignes modernes et essentielles, disponible en six tailles différentes qui lui permettent de s'adapter à tout type d'espace. Son point fort est la possibilité de décliner le plateau en plusieurs finitions pour satisfaire tous les goûts.

Slim is an extendable table with modern and essential lines, available in six different sizes that make it able to adapt to any type of space. Its strong point is the possibility of declinating the top in multiple finishes to satisfy all tastes.



ZEUS

Tavolo allungabile disponibile in quattro varianti di misura, per ognuna delle quali è prevista una prolunga. Apprezzabile per la sua elevata versatilità ed adattabilità ad ogni tipo di ambiente della casa.

Table extensible disponible en quatre tailles, pour chacune desquelles une extension est fournie. Appréciable pour sa grande polyvalence et son adaptabilité à tout type d'environnement domestique.

Extendable table available in four sizes, for each of which an extension is provided. Appreciable for its high versatility and adaptability to any type of home environment.

B-LAME

Il nome stesso esplica il suo design: due lame in metallo, impreziosite da un inserto che richiama la finitura del piano, un segno distintivo che dà spazio ad una creatività estetica infinita.

Le nom lui-même exprime son design: deux lames métalliques, agrémentées d'un insert qui rappelle la finition du plan, signe distinctif qui laisse place à une infinie créativité esthétique.

Its name itself expresses its design: two metal blades, embellished with an insert that recalls the finish of the top, a distinctive sign that gives space to an infinite aesthetic creativity.



KRYOS

Una moderna reinterpretazione del vecchio cavalletto, un'idea fresca per sostenere piani rettangolari completi di una buona offerta di dimensioni e finiture.

Une réinterprétation moderne de l'ancien chevalet, une nouvelle idée pour soutenir des plans rectangulaires avec une bonne offre de dimensions et de finitions.

A modern reinterpretation of the old easel, a fresh idea to support rectangular tops with a wide offer of dimensions and finishes.

05

MATERIALS

Ricerchiamo e selezioniamo con grande cura materiali e texture in modo che possano soddisfare gusti e budget differenti. Si tratta di una ricerca stilistica che tiene in considerazione mode, tendenze, usi e costumi del mondo che ci circonda.

Nous recherchons et sélectionnons les matériaux et textures avec le plus grand soin afin qu'ils puissent satisfaire différents goûts et budgets. Il s'agit d'une recherche stylistique qui prend en compte les modes, les tendances et les coutumes du monde qui nous entoure.

We seek and pick materials and textures with great care so that they can satisfy different tastes and budgets. It is a stylistic research that takes into account fashions, trends and customs of the world around us.

METALLI VERNICIATI

MÉTAUX PEINTS / PAINTED METALS

Sp. 12 mm



ROCK RK1 BASALTO

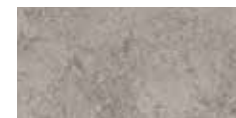

ROCK RK3 TECNORITE



ROCK RK5 GRAFITE

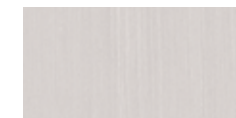

BRUSHED STONE
SB1 BIANCO



BRUSHED STONE
SB2 SABBIA



BRUSHED STONE SB4 LAVA



CANVAS CN1 BIANCO



CANVAS CN2 SABBIA



CANVAS CN3 CENERE



METAL RAW MR1 FERRO



METAL RAW MR3 PIOMBO



METAL RAW MR4
BRONZO

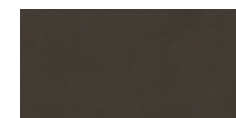

METAL DUST MD1 BRONZE*



METAL DUST CHAMPAGNE*

Disponibili per / disponibles pour / available for: T80

*Disponibili per / disponibles pour / available for: T70

LAMINAM

LAMINAM /LAMINAM



PORFIDO MARRONE FIAMMATO



PIETRA DI CARDOSO NERO
FIAMMATO



PIETRA PIASENTINA
GRIGIO FIAMMATO



TRAVERTINO GRIGIO
VENATO BOCCIARDATO



PIETRA DI SAVOIA PERLA
BOCCIARDATA



DIAMOND CREAM

Disponibili per / disponibles pour / available for: T70

MDi by INALCO

MDi by Inalco / MDi by Inalco



AZALAI NEGRO NATURAL



UMBRA MARRON
ABUJARDADO



BALKAN NEGRO



METEORA GRIS
ABUJARDADO



TOTEM GRIS
ABUJARDADO



SELENE SUPER
BLANCO GRIS

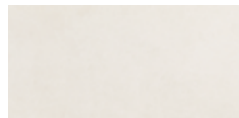

ANANDA BLANCO
ARENADO

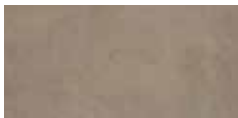

JASPER MOKA
ABUJARDADO

Disponibili per / disponibles pour / available for: T70

Sp. 22 mm

DEKTON

Sp. 22 mm



KELYA



SIRIUS



AURA 15



LAURENT



BROMO

Disponibili per / disponibles pour / available for: T70

Sp. 22 mm

VETRI

VITRÈE / GLASS

Sp. 22 mm

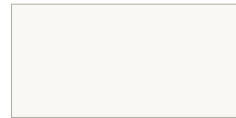

725 BIANCO LIGHT

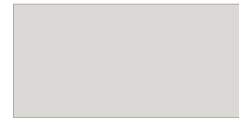

702 SABBIA

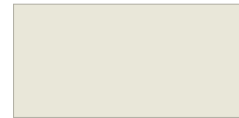

703 CORDA

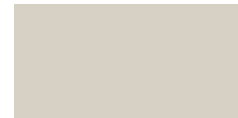

742 SOIA



743 CAMOSCIO



729 ROCCIA



710 ANTRACITE



711 NERO



730 CARMELLO



748 MARSALA



732 MUSCHIO



9BO OPACO CAMPIONE

Disponibili per / disponibles pour / available for: T70

LEGNO ANTICO

VIEUX BOIS / OLD WOOD

Sp. 22/24 mm



ROVERE KOMI



ABETE TALCO



ABETE MULTICOLOR



Venatura verticale
Veinure verticale
Vertical grain

ANTA LISCIA (Sp. 22 mm) / PORTE LISSE / SMOOTH DOOR
Disponibili per / disponibles pour / available for: K105 - KATE - KELLY COLLECTION

ANTA TELAIO (Sp. 24 mm) / PORTE CADRE / FRAME DOOR
Disponibili per / disponibles pour / available for: K105 Collection

ROVERE- ROVERE PLISSÈ

CHENE - CHENE PLISSÈ / OAK - PLISSÈ OAK

Sp. 23 mm



ROVERE GRANO



ROVERE GHIANDA



ROVERE SILVERY



ROVERE CASTORO



Venatura verticale
Veinure verticale
Vertical grain



ROVERE LAVA

Disponibili per / disponibles pour / available for: K105 - PLISSÈ - KATE - KELLY COLLECTION - T70 - T80

ROVERE NODATO

CHENE NOUE / KNOTTED OAK



NODATO GRANO



NODATO GHIANDA



NODATO SILVERY



NODATO CASTORO



NODATO LAVA

Disponibili per / disponibles pour / available for: K105 - KATE - KELLY COLLECTION

ROVERE VINTAGE

CHENE VINTAGE / VINTAGE OAK



VINTAGE GRANO



VINTAGE GHIANDA



VINTAGE SILVERY



VINTAGE CASTORO



VINTAGE LAVA

Disponibili per / disponibles pour / available for: K105 - KATE - KELLY COLLECTION

Sp. 23 mm

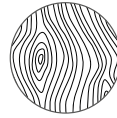

Venatura verticale
Veinure verticale
Vertical grain

TERMOCOTTO

CHENE TERMOCOTTO / TERMOCOTTO OAK



ROVERE TERMOCOTTO

DISPONIBILI PER / DISPONIBLES POUR / AVAILABLE FOR: K105 - KATE - KELLY COLLECTION

OLMO

ORME / ELM



OLMO BIONDO



OLMO GOLD



OLMO CUIOIO



OLMO CARRUBA

DISPONIBILI PER / DISPONIBLES POUR / AVAILABLE FOR: K105 - KATE - KELLY COLLECTION

NOCE CANALETTO

NOYER CANALETTO / WALNUT CANALETTO



NOCE CANALETTO

DISPONIBILI PER / DISPONIBLES POUR / AVAILABLE FOR: K105 - KATE - KELLY COLLECTION

Sp. 23 mm



Venatura verticale
Veinure verticale
Vertical grain

Sp. 23 mm



Venatura verticale
Veinure verticale
Vertical grain

Sp. 23 mm

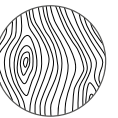

Venatura verticale
Veinure verticale
Vertical grain

MDF LACCATO "METALLO LIQUIDO"

MDF LAQUE "METALLO LIQUIDO" / "METALLO LIQUIDO" LACQUERED MDF

Sp. 22 mm



ORO ROSA

ZIRCONIO

SILICIO

MAGNESIO

ORO ROSA OLD



ZIRCONIO OLD

SILICIO OLD

MAGNESIO OLD

Disponibili per / disponibles pour / available for: K105 - KATE - KELLY COLLECTION

ACCIAIO INOX

ACIER INOX / INOX STEEL

Sp. 22 mm



ACCIAIO SATINATO

ACCIAIO VINTAGE

Disponibili per / disponibles pour / available for: K105 COLLECTION

FENIX

Sp. 22 mm



BIANCO KOS*

BIANCO DOVER

BEIGE LUXOR

BEIGE ARIZONA*

CASTORO OTTAWA



VERDE COMMODORO

BLU FES

GRIGIO ANTRIM

GRIGIO EFESO*

GRIGIO LONDRA*

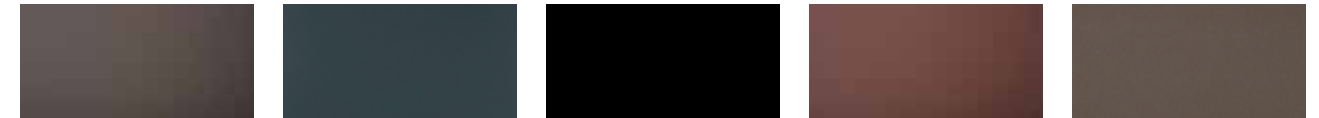

CACAO ORINOCO

GRIGIO BROMO

NERO INGO*

ROSSO JAIPUR

BRONZO DOHA*



ZINCO DOHA*

TITANIO DOHA

PIOMBO DOHA

Disponibili per / disponibles pour / available for: K105 - KATE - KELLY - ISABEL - ALEXIA COLLECTION

*Disponibili per / disponibles pour / available for: T80 - T70

LAMINATO BORDO UNICOLOR

STRATFIE CHANT UNICOLOR / LAMINATE WITH UNICOLOR EDGE

Sp. 22 mm

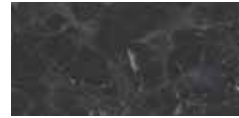

IMPERO



KEOPE



TABAK*



PERLINO

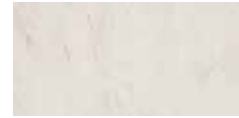

HIMALAYA



JUPITER



STATUARIO



MAILAND*



ROX BLACK*



PELTRO*

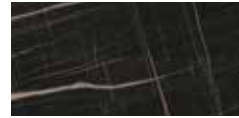

SAHARA NOIR*



RIO BRAVO*



DIONYSUS*

Disponibili per / disponibles pour / available for: K105 - KATE - KELLY COLLECTION - ALEXIA - ISABEL

*Disponibili per / disponibles pour / available for: T70

LAMINATO LUCIDO

STRATFIE BRILLANT / GLOSSY LAMINATE

Sp. 22 mm

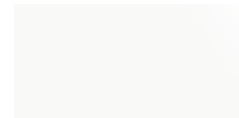

BIANCO

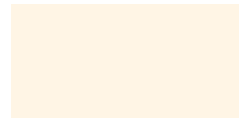

PANNA



VISONE



GRIGIO PERLA

Disponibili per / disponibles pour / available for: K105 - KATE - KELLY - ISABEL - ALEXIA COLLECTION

MELAMINICO TERMOSTRUTTURATO

MELAMINE THERMO-STRUCTURE / THERMO-STRUCTURED MELAMINE

Sp. 22 mm



SHERWOOD COGNAC



SHERWOOD MIELE



ROVERE PAGLIA



ROVERE DUNA



ROVERE CORTECCIA



ROVERE ARDESIA



ROVERE ALASKA

Disponibili per / disponibles pour / available for: K105 - KATE - KELLY - ISABEL - ALEXIA COLLECTION



Venatura verticale
Veinure verticale
Vertical grain

MELAMINICO OPACO

MELAMINE MAT / MATT MELAMINE

Sp. 22 mm

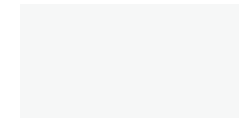

BIANCO



GRIGIO CENERE



TANNO



TERRA DI SIENA



GRIGIO FUMO



GRIGIO ONICE



AMARANTO



VERDE TUNDRA



ARAGOSTA

Disponibili per / disponibles pour / available for: K105 - KATE - KELLY - ISABEL - ALEXIA COLLECTION

MELAMINICO EFFETTO LEGNO

MELAMINE EFFET BOIS / WOOD EFFECT MELAMINE



WOOD NOCE*



OLMO NATURAL



ROVERE KRONOS



ROVERE CRUDO



QUERCIA JUTA



QUERCIA FARRO



QUERCIA CAFFÈ



QUERCIA DARK



NOCE BIONDO

Sp. 22 mm



***Venatura orizzontale**
Veinure horizontale
Horizontal grain



Venatura verticale
Veinure verticale
Vertical grain

Disponibili per / disponibles pour / available for: K105 - KATE - KELLY - ISABEL - ALEXIA COLLECTION

MELAMINICO EFFETTO MATERICO

MELAMINE EFFET MATERIQUE / MATERIAL EFFET MELAMINE

Sp. 22 mm



CALCE SILVER

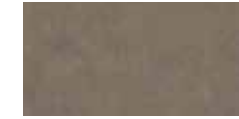

CALCE BROWN



OSSIDO CORTEN



TEXIL GRAY



TEXIL DARK



METAL GREY



METAL BROWN

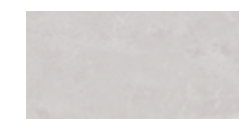

OSSIDO GHIACCIO



PIETRA BALTICA

Disponibili per / disponibles pour / available for: K105 - KATE - KELLY - ISABEL - ALEXIA COLLECTION

MDF LACCATO OPACO

MDF LAQUE MAT / MATT LACQUERED MDF

Sp.22 mm

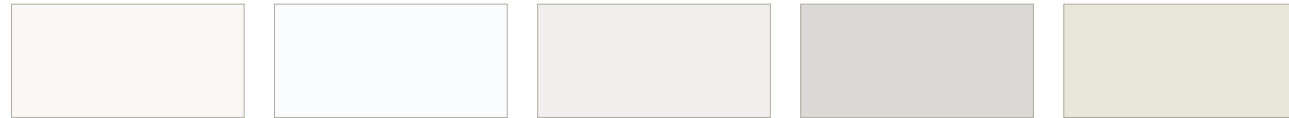

725 BIANCO LIGHT* 700 BIANCO 705 GHIAIA 702 SABBIA* 703 CORDA*



708 CUOIO 729 ROCCIA* 709 PIOMBO 710 ANTRACITE* 711 NERO*



724 BLU NOTTE 731 DANUBIO 744 ARTICO 746 SENAPE 707 TERRA



706 FANGO 732 MUSCHIO* 720 VERDE FORESTA 742 SOIA* 743 CAMOSCIO*



745 SIGARO 730 CARAMELLO* 718 PRUGNA 748 MARSALA* 747 CORALLO



715 ROSSO 734 BIANCO NUVOLA MATT 735 PLATINO MATT 736 ARDESIA MATT 737 NERO ASSOLUTO MATT

Disponibili per / disponibles pour / available for: K105 - KATE - KELLY - ISABEL - ALEXIA COLLECTION - T70 - T80

*Disponibili per / disponibles pour / available for: PLISSÉ

MDF LACCATO LUCIDO

MDF LAQUE BRILLANT / GLOSSY LACQUERED MDF

Sp.22 mm

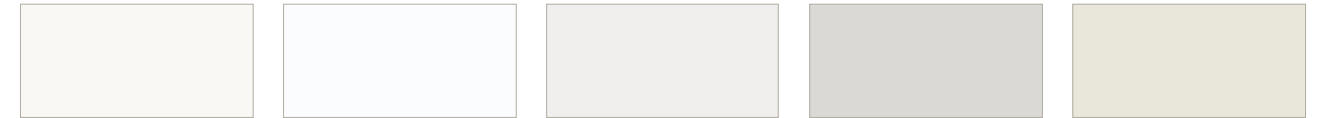

725 BIANCO LIGHT 700 BIANCO 705 GHIAIA 702 SABBIA 703 CORDA



708 CUOIO 729 ROCCIA 709 PIOMBO 710 ANTRACITE 711 NERO



724 BLU NOTTE 731 DANUBIO 744 ARTICO 746 SENAPE 707 TERRA



706 FANGO 732 MUSCHIO 720 VERDE FORESTA 742 SOIA 743 CAMOSCIO



745 SIGARO 730 CARAMELLO 718 PRUGNA 748 MARSALA 747 CORALLO

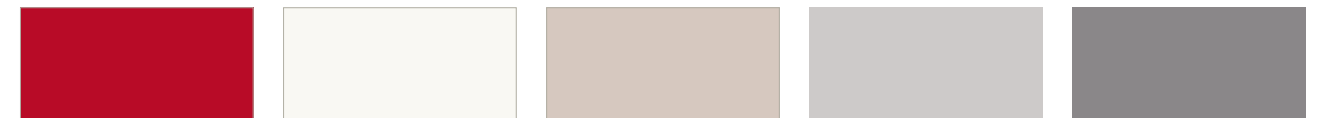

715 ROSSO 738 BIANCO GHIACCIO BRILL 739 CASHMERE BRILL 740 ARGENTO BRILL 741 FERRO BRILL

Disponibili per / disponibles pour / available for: K105 - KATE - KELLY - ISABEL - ALEXIA COLLECTION

POLIMERICO EFFETTO LEGNO MATT

POLYMER EFFET BOIS MAT / WOOD EFFECT MATT POLYMER



LARICE NEVE



LARICE GRIGIO ARGENTO



PINO GRIGIO

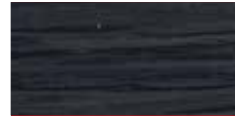

ROVERE NERO

Sp. 20 mm



Venatura orizzontale
Veinure horizontale
Horizontal grain

Disponibili per / disponibles pour / available for: KALEA - QUADRA

POLIMERICO EFFETTO MATERICO

POLYMER EFFET MATERIQUE / MATERIAL EFFET POLYMER



CEMENTO SABBIA



CEMENTO GRIGIO

Disponibili per / disponibles pour / available for: KALEA - QUADRA

POLIMERICO LUCIDO

POLYMER BRILLANT / GLOSSY POLYMER

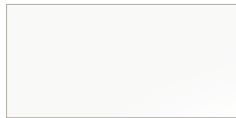

BIANCO NEVE LUCIDO



CAPPUCCINO LUCIDO



CAFFÈ LUCIDO



LAGUNA LUCIDO



BASALTO LUCIDO



SELCE LUCIDO

Disponibili per / disponibles pour / available for: KALEA - QUADRA

POLIMERICO MATT

POLYMER MAT/ MATT POLYMER

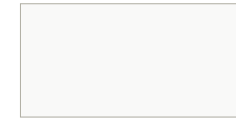

BIANCO LATTE MATT



PIETRA MATT



SASSO SUPER MATT



ANTRACITE SUPER MATT



DARK SUPER MATT

Sp. 20 mm



VERDE SUPER MATT

Disponibili per / disponibles pour / available for: KALEA - QUADRA

Sp. 20 mm

YOUNG COLLECTION

MELAMINICO OPACO SOFT

MELAMINE MAT / MATT MELAMINE

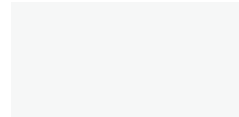

BIANCO SOFT



PANNA SOFT



TORTORA SOFT



VISONE SOFT

Disponibili per / disponibles pour / available for: TIFFANY - CLOÈ COLLECTION

MDF LACCATO OPACO 1 LATO

MELAMINE LAQUE MAT 1 FACE / 1 SIDE MATT LACQUERED MELAMINE

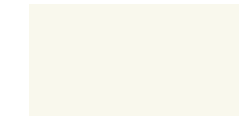

BIANCO NUVOLE MATT



PLATINO MATT



ARDESIA MATT

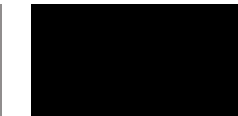

NERO ASSOLUTO MATT

Disponibili per / disponibles pour / available for: TIFFANY - CLOÈ COLLECTION

MDF LACCATO LUCIDO 1 LATO

MELAMINE LAQUE BRILLANT 1 FACE / 1 SIDE GLOSSY LACQUERED MELAMINE

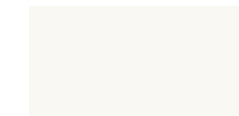

BIANCO GHIACCIO BRILL



CASHMERE BRILL



ARGENTO BRILL



FERRO BRILL

Disponibili per / disponibles pour / available for: TIFFANY - CLOÈ COLLECTION

Sp. 20 mm

YOUNG COLLECTION

MELAMINICO EFFETTO LEGNO

MELAMINE EFFET BOIS / WOOD EFFECT MELAMINE



ROVERE BRANDY



ROVERE BIANCO



ROVERE SINAI



ROVERE CENERE

Disponibili per / disponibles pour / available for: TIFFANY - CLOÈ COLLECTION

ROVERE FIAMMATO YOUNG

CHÊNE FLAMMÉ YOUNG / FLAMED YOUNG OAK



ROVERE FIAMMATO AMBRA

Disponibili per / disponibles pour / available for: TIFFANY - CLOÈ COLLECTION

Sp. 19 mm

Sp. 19 mm

Sp. 20 mm



Venatura orizzontale
Veinure horizontale
Horizontal grain

Sp. 19 mm



Venatura verticale
Veinure verticale
Vertical grain

ANTA VETRO

Porte Vitreè / Glass Door

FINITURA TELAIO

FINITION CADRE / FRAME FINISH



ALLUMINIO BRONZO TITANIO

Disponibili per / disponibles pour / available for:
TELAIO T45



GRAFITE

Disponibile per / disponible pour / available for:
TELAIO T60

VETRO

VERRES / GLASS



SATINATO TRASPARENTE



FUMÈ STOPSOL

Disponibili per / disponibles pour / available for:
TELAIO T45



TRASPARENTE FUMÈ



STOPSOL

Disponibili per / disponibles pour / available for:
TELAIO T60

VETRO LACCATO

VERRES LAQUÈS / LACQUERED GLASS

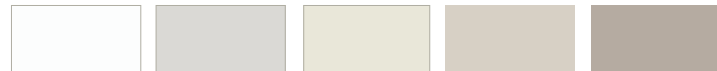

725 BIANCO LIGHT 702 SABBIA 703 CORDA 742 SOIA 743 CAMOSCIO



729 ROCCIA 710 ANTRACITE 041 NERO 730 CARAMELLO 748 MARSALA



732 MUSCHIO

9B0 OPACO CAMPIONE

Disponibili per / disponibles pour / available for: TELAIO T45

Sp. 4 mm

Sp. 4 mm

TELAIO T60

Cadre T60 / Frame T60

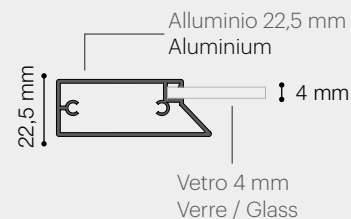

TELAIO T45

Cadre T45 / Frame T45

01 Senza maniglia / sans poignée / without handle

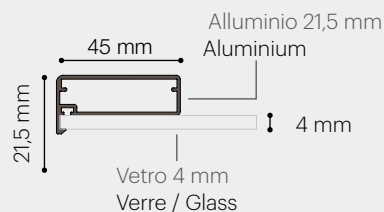

02 Profilo maniglia tutta altezza / avec profil poignée toute hauteur / with all-height handle profile

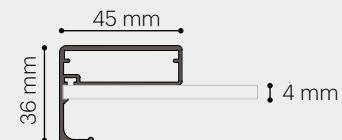

03 Con maniglia incassata piccola / avec petite poignée encastrée / with little inlay handle

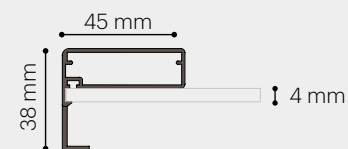

GOLE/ZOCCOLI

Gorge / Socles
Groove profiles / Plinths

FINITURE GOLE E ZOCCOLI

FINITIONS DE GORGES ET SOCLES / GROOVES AND PLINTH FINISHES



BIANCO OPACO



O CHIMICO



ACCIAIO SATINATO



BRONZO TITANIO



GRAFITE



METAL DUST CHAMPAGNE



ORO ROSA

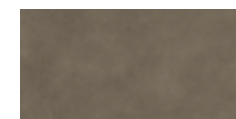

ZIRCONIO

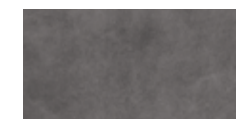

SILICIO



MAGNESIO



ROCK RK1 BASALTO

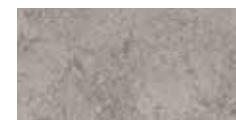

ROCK RK3 TECNORITE



ROCK RK5 GRAFITE

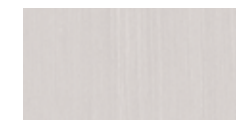

BRUSHED STONE
SB1 BIANCO



BRUSHED STONE
SB2 SABBIA



BRUSHED STONE SB4
LAVA



CANVAS CN1 BIANCO



CANVAS CN2 SABBIA



CANVAS CN3 CENERE



METAL RAW MR1 FERRO



METAL RAW MR3 PIOMBO



METAL RAW MR4
BRONZO

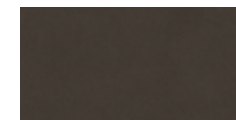

METAL DUST MD1 BRONZE



LACCATO LUCIDO E OPACO
(VEDI CAMPIONARIO ZECCHINON)
Laquè brillante et matte (voir la palette Zecchinon) / Glossy and matt laquer (see Zecchinon range).

ZECCHINON CUCINE si riserva il diritto di apportare, senza preavviso, ogni modifica mirata al miglioramento funzionale e qualitativo dei propri prodotti. Testi e disegni presenti in questo stampato hanno scopo divulgativo: per ogni aspetto tecnico e dimensionale fare riferimento ai listini aziendali e relativi aggiornamenti. I campioni di colori e materiali hanno valore indicativo.

PER AGGIORNAMENTI RELATIVI ALLE FINITURE CONSULTATE SEMPRE IL NOSTRO SITO WWW.ZECCHINON.IT

ZECCHINON CUCINE reserves the right to make without notice any changes aimed at improving the functions and qualities of its products. The texts and drawings in this publication are purely for advertising purposes: for technical and dimensional aspects consult the company price lists and updates. Colour and material samples are indicative.

FOR UPDATES ON MATERIALS AND FINISHES, ALWAYS VISIT OUR WEBSITE WWW.ZECCHINON.IT

ZECCHINON CUCINE se réserve le droit d'apporter, sans préavis, toute modification destinée à l'amélioration fonctionnelle et qualitative de ses produits. Les textes et les dessins présents dans cet imprimé sont divulgués à titre informatif: pour tout aspect technique et de dimension, se référer aux listes d'entreprise et leurs mises à jour correspondantes. Les échantillons de couleur et les matériaux ont une valeur indicative.

POUR DES MISES A JOUR CONCERNANT DES MATERIAUX ET DES FINITIONS CONSULTEZ TOUJOURS NOTRE SITE WWW.ZECCHINON.IT

Design

Zecchinon R&D + Haften Studio

Art Direction and Graphics

Haften Studio

Virtual images

Neiko

Print

Grafiche Italprint

100 % MADE IN ITALY



ZECCHINON CUCINE srl

Via Castello, 133
31020 - Sernaglia della Battaglia (TV)

ITALIA

tel +39 0438 860341

www.zecchinon.it



