



**ARDECO | YOKO.**



## YOKO Collection

/ Essenzialità materica.

I volumi essenziali delle basi folding ed i nuovi elementi orizzontali a giorno eliminano ogni vincolo visivo ed esaltano i profili minimali e decisi delle ante.

Cornici contenitive che delimitano ma che, allo stesso tempo, valorizzano e definiscono nuove possibilità materiche: vetri, specchi, gres, laccati ed essenze sono la nuova veste dei frontali della collezione Yoko by Ardeco.

/ Materic essentiality.

The essential volumes of the miter-folded cabinets and the new horizontal open elements eliminate all visual constraints and enhance the minimal and resolute profiles of the doors.

Frames that delimit the space and, at the same time, enhance and define new materic finishes: glass, mirror, porcelain stoneware, wood or lacquered colours.

A new look for the fronts of the Yoko collection by Ardeco.

/ Essence matériqque.

Les volumes essentiels des meubles bas avec « angles pliés à 90° » et des nouveaux éléments horizontaux ouverts, éliminent toutes les contraintes visuelles et mettent en valeur les profils minimalistes et résolus des portes.

Des cadres qui contiennent et délimitent, mais en même temps renforcent et définissent de nouvelles possibilités matérielles : verres, miroirs, grès cérame, laquées et bois sont le nouveau look des façades de la collection Yoko by Ardeco.

/ Materische Wesentlichkeit .

Die essentiellen Volumen der Unterschränke mit Eckverbindung auf Gehrung und die neuen horizontalen offenen Elemente beseitigen alle visuellen Beschränkungen und betonen die minimalistischen und resoluten Profile der Türen. Der Rahmen ist ein begrenzendes Element, das jedoch gleichzeitig neue Materialmöglichkeiten aufwertet und definiert. Glas, Spiegel, Feinsteinzeug, lackierte Farben oder Holz furniert: das ist das neue Look der Fronten der Kollektion Yoko by Ardeco.

Design | Enrico Cesana

## / Un profilo minimale, una cornice che ridisegna il concetto di bagno.

Le ante frontali della collezione Yoko sono composte da un vassoio metallico laccato, che integra nel suo design la gola d'apertura. Posta orizzontalmente su basi e pensili, offre infinite combinazioni, donando segni grafici differenti alle composizioni bagno.

/ A minimal profile, a frame that redesigns the bathroom concept. The front doors of the Yoko collection are composed of a lacquered metal panel with an integrated horizontal groove both on cabinets and on wall units. It offers endless combinations, giving different graphic signs to bathroom compositions.

/ Un profil minimaliste, un cadre qui redessine le concept de la salle de bains. Les façades de la collection Yoko sont composées d'un panneau en métal laqué, qui intègre la gorge dans son design. Placée horizontalement sur les meubles bas et hauts, offre des combinaisons infinies, donnant des signes graphiques différents aux compositions de la salle de bains.

/ Ein minimalistischer Rahmen, der das Konzept des Badezimmers neu interpretiert. Die Fronten der Kollektion Yoko bestehen aus einer lackierten Metallplatte, in deren Design die Griffmulde integriert ist. Horizontal auf Unter- und Hängeschränken platziert, bietet sie zahllose Kombinationsmöglichkeiten und verleiht den Badmöbelzusammenstellungen verschiedene grafische Zeichen.



# #01

Comp. YO 01 L. 240 x P. 50 x H. 50 cm

/ Contrasti  
metropolitani.

/ Metropolitan contrasts.  
/ Contrastes métropolitains  
/ Metropolitane Kontraste.

Grigio Cemento opaco - Frontali Gres Pietra Grey - Lavabo Cube Grigio Cemento -  
Specchiera Illusion - Pensili Bird Grigio Cemento opaco - Barra Mikado Grigio Cemento opaco

/ Grigio Cemento Matt - Pietra Grey porcelain  
stoneware fronts - Cube washbasin, Grigio Cemento -  
Mirror Illusion - Wall Units Bird, Grigio Cemento Matt -  
Mikado Bar, Grigio Cemento Matt

/ Grigio Cemento mat - Façades en grès Pietra Grey -  
Vasque Cube Grigio Cemento - Miroir Illusion -  
Meubles ouverts Bird Grigio Cemento mat - Barre  
Mikado Grigio Cemento mat

/ Grigio Cemento matt - Fronten aus Feinsteinzeug  
Pietra Grey - Waschbecken Cube Grigio Cemento -  
Spiegel Illusion - Hängeschränke Bird Grigio Cemento  
matt - Handtuchhalter Mikado Grigio Cemento matt







Total Bathroom by Ardeco.  
 Box doccia mod. Run Grigio Cemento opaco di Agha  
 - Piatto mod. Blend Bianco di Agha.



/ Total Bathroom by Ardeco.  
 Shower enclosure mod. Run by Agha, Grigio  
 Cemento Matt - Shower Tray mod.  
 Blend by Agha, White

/ Total Bathroom by Ardeco.  
 Paroi de douche by Agha mod. Run, Grigio  
 Cemento mat - Receveur mod.  
 Blend by Agha, Blanc.

/ Total Bathroom by Ardeco.  
 Duschabtrennung mod.  
 Run Grigio Cemento matt by Agha  
 - Duschwanne mod. Blend by Agha, Weiß.



I frontali in Gres renderanno unico ed elegante il tuo bagno.

---

/ Porcelain stoneware fronts will make your bathroom unique and elegant.

/ Les façades en grès rendront votre salle de bains unique et élégante.

/ Die Fronten aus Feinsteinzeug machen Ihr Bad einzigartig und elegant.

# #01 C'è una composizione per ogni spazio!

Grigio Cemento opaco - Frontali Gres Pietra Grey - Lavabo Cube Grigio Cemento - Specchiera Illusion - Pensili Bird Grigio Cemento opaco - Barra Mikado Grigio Cemento opaco

## #01

Comp. YO 01  
L. 240 x P. 50 x H. 50 cm



## #01A

Comp. YO 01A  
L. 155 x P. 50 x H. 50 cm



/ There is a composition for every space!

/ Grigio Cemento Matt - Pietra Grey porcelain stoneware fronts - Cube washbasin, Grigio Cemento - Mirror Illusion - Wall Units Bird, Grigio Cemento Matt - Mikado Bar, Grigio Cemento Matt

/ Il y a une composition pour chaque espace!

/ Grigio Cemento mat - Façades en grès Pietra Grey - Vasque Cube Grigio Cemento - Miroir Illusion - Meubles ouverts Bird Grigio Cemento mat - Barre Mikado Grigio Cemento mat

/ Wir haben eine Komposition für jeden Raum!

/ Grigio Cemento matt - Fronten aus Feinsteinzeug Pietra Grey - Waschbecken Cube Grigio Cemento - Spiegel Illusion - Hängeschränke Bird Grigio Cemento matt - Handtuchhalter Mikado Grigio Cemento matt

## #01B

Comp. YO 01B  
L. 120 x P. 50 x H. 50 cm



## #01C

Comp. YO 01C  
L. 120 x P. 50 x H. 37,5 cm





# #02

Comp. YO 02 L. 205 x P. 50 x H. 50 cm

/ Armonia  
soffusa.

/ Soft harmony.  
/ Harmonie douce.  
/ Zarte Armonie.

Grigio Fumo opaco - Nero opaco - Frontali Specchio Grigio Europa -  
Lavabo Cube Grigio Fumo - Specchiera Display Nero opaco

/ Grigio Fumo matt - Nero matt - Mirror Fronts,  
Grigio Europa - Washbasin Cube, Grigio Fumo -  
Mirror Display, Nero matt

/ Grigio Fumo mat - Noir mat - Façades en miroir  
Gris Europe - Vasque Cube, Grigio Fumo - Miroir  
Display, Noir Mat

/ Grigio Fumo matt - Nero matt - Fronten aus  
Spiegel Grigio Europa - Waschbecken Cube Grigio  
Fumo - Spiegel Display Nero matt







Scopri la geometria minimale del nuovo lavabo mod. Cube Grigio Fumo.  
 Vasca mod. Giada Bianco opaco.



/ Discover the minimalist geometry  
 of the new washbasin mod. Cube, Grigio Fumo.  
 Bathtub mod. Giada, Bianco matt.

/ Découvrez la géométrie minimaliste du nouveau  
 lavabo mod. Cube, Grigio Fumo.  
 Baignoire mod. Giada, Blanc Mat.

/ Entdecken Sie die minimalistische Geometrie des  
 neuen Waschbecken mod. Cube Grigio Fumo.  
 Badewanne mod. Giada Weiß matt.

# #02 C'è una composizione per ogni spazio!

Grigio Fumo opaco - Nero opaco - Frontali Specchio Grigio Europa - Lavabo Cube Grigio Fumo - Specchiera Display Nero opaco

## #02

Comp. YO 02  
L. 205 x P. 50 x H. 50 cm



## #02A

Comp. YO 02A  
L. 190 x P. 50 x H. 50 cm



/ There is a composition for every space!

/ Grigio Fumo matt - Nero matt - Mirror Fronts, Grigio Europa - Washbasin Cube, Grigio Fumo - Mirror Display, Nero matt

/ Il y a une composition pour chaque espace!

/ Grigio Fumo mat - Noir mat - Façades en miroir Gris Europe - Vasque Cube, Grigio Fumo - Miroir Display, Noir Mat

/ Wir haben eine Komposition für jeden Raum!

/ Grigio Fumo matt - Nero matt - Fronten aus Spiegel Grigio Europa - Waschbecken Cube Grigio Fumo - Spiegel Display Nero matt

## #01B

Comp. YO 02B  
L. 155 x P. 50 x H. 50 cm



## #02C

Comp. YO 02C  
L. 140 x P. 50 x H. 50 cm



# #03

Comp. YO 03 L. 220 x P. 50 x H. 25 cm

/ Sfumature  
tono su tono.

/ Tone-on-tone shading.  
/ Teintes ton sur ton  
/ Ton-in-Ton Schattierungen.

Cachi opaco - Mattone opaco - Frontali Cachi Opaco -  
Lavabo Mistral Mattone - Specchiera Round

/ Cachi matt - Mattone matt - Fronts Cachi Matt  
Top with integrated basin Mistral Mattone -  
Mirror Round

/ Cachi mat - Mattone mat - Façades laquées,  
Cachi mat - Plan vasque Mistral Mattone -  
Miroir Round

/ Cachi matt - Mattone matt - Lackierte Fronten,  
Cachi Matt - Waschtisch Mistral Mattone -  
Spiegel Round

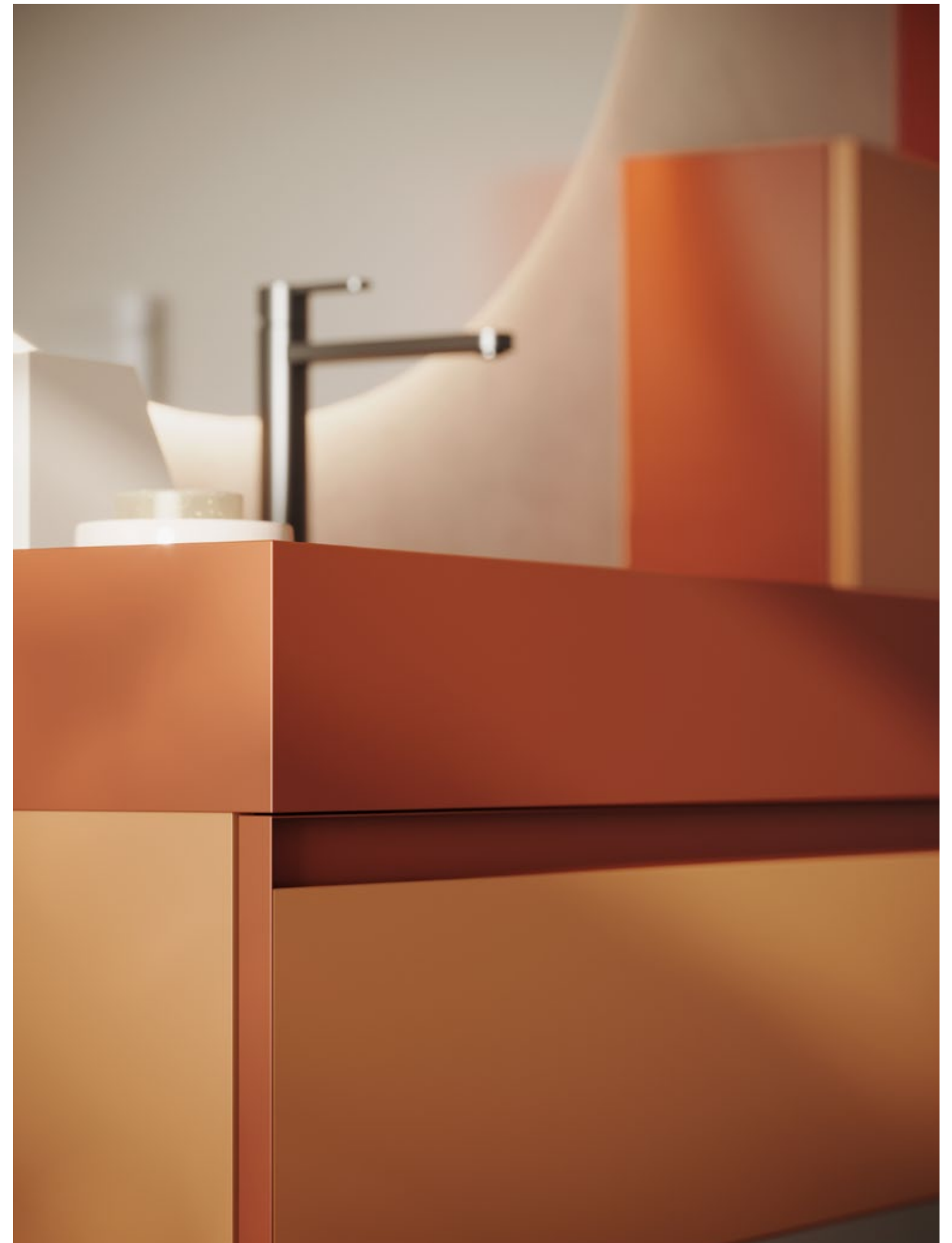





Gioca con le diverse profondità tra basi e pensili.  
Top mod. Mistral in Mineral Tech Mattone.



/ Play with the different depths of cabinets  
and wall units.  
Top with integrated basin mod. Mistral,  
Mineral Tech Mattone.

/ Jouez avec les différentes profondeurs  
des meubles bas et hauts.  
Plan vasque mod. Mistral en Mineral Tech,  
Mattone.

/ Spielen Sie mit den unterschiedlichen Tiefen  
zwischen Unter- und Hängeschränken.  
Waschtisch aus Mineral Tech mod. Mistral,  
Farbe Mattone.

# #03 C'è una composizione per ogni spazio!

Cachi opaco - Mattone opaco - Frontali Cachi Opaco -  
Lavabo Mistral Mattone - Specchiera Round

## #03

Comp. YO 03  
L. 220 x P. 50 x H. 25 cm



## #03A

Comp. YO 03A  
L. 170 x P. 50 x H. 25 cm



/ There is a composition for every space!

/ Cachi matt - Mattone matt - Fronts Cachi Matt  
Top with integrated basin Mistral Mattone -  
Mirror Round

/ Il y a une composition pour chaque espace!

/ Cachi mat - Mattone mat - Façades laquées,  
Cachi mat - Plan vasque Mistral Mattone -  
Miroir Round

/ Wir haben eine Komposition für jeden Raum!

/ Cachi matt - Mattone matt - Lackierte Fronten,  
Cachi Matt - Waschtisch Mistral Mattone -  
Spiegel Round

## #03B

Comp. YO 03B  
L. 170 x P. 50 x H. 25 cm



## #03C

Comp. YO 03C  
L. 145 x P. 50 x H. 25 cm





# #04

Comp. YO 04 L. 240 x P. 50 x H. 37,5 cm

/ Equilibrio  
pastello.

/ Balance of pastel colours.  
/ Equilibre en pastel.  
/ Pastell-Balance.

Creta Opaco - Frontali HPL Botticino - Lavabo HPL Botticino -  
Specchiera Area

/ Creta Matt - Fronts HPL Botticino - Top with  
integrated basin HPL Botticino - Mirror Area

/ Creta mat - Façades HPL Botticino - Plan vasque  
HPL Botticino - Miroir Area

/ Creta Matt - Fronten aus HPL Botticino -  
Waschtisch HPL Botticino - Spiegel Area





Pensile con apertura a ribalta ed elemento portasalviette da posizionare sottopensile.  
 Box doccia mod. Separé Nero opaco di Agha.  
 - Piatto mod. Step S Bianco di Agha.



/ Wall unit with bottom-hung door and towel holder, placed under the wall cabinet.  
 Shower enclosure mod. Separé by Agha, Black matt, with LED light.  
 - Shower tray mod. Step S by Agha, White.

/ Meuble haut avec porte abattante et porte-serviettes à positionner au-dessous.  
 Paroi de douche mod. Separé Noir Matt by Agha avec éclairage LED.  
 - Receveur de douche blanc Step S by Agha.

/ Hängeschrank mit Klappenöffnung und unten hängendem Handtuchhalter.  
 Duschabtrennung mod. Separé Nero matt by Agha komplett mit LED Licht.  
 - Duschwanne mod. Step S Weiß by Agha.



# #04 C'è una composizione per ogni spazio!

Creta Opaco - Frontali HPL Botticino - Lavabo HPL Botticino - Specchiera Area

## #04

Comp. YO 04  
L. 240 x P. 50 x H. 37,5 cm



## #04A

Comp. YO 04A  
L. 190 x P. 50 x H. 37,5 cm



/ There is a composition for every space!

/ Creta Matt - Fronts HPL Botticino - Top with integrated basin HPL Botticino - Mirror Area

/ Il y a une composition pour chaque espace!

/ Creta mat - Façades HPL Botticino - Plan vasque HPL Botticino - Miroir Area

/ Wir haben eine Komposition für jeden Raum!

/ Creta Matt - Fronten aus HPL Botticino - Waschtisch HPL Botticino - Spiegel Area

## #04B

Comp. YO 04B  
L. 140 x P. 50 x H. 37,5 cm



## #04C

Comp. YO 04C  
L. 120 x P. 50 x H. 37,5 cm



# #05

Comp. YO 05 L. 195 x P. 50 x H. 50 cm

/ Riflessi  
d'autore.

/ Artistica reflections  
/ Réflexions artistiques  
/ Künstlerische Reflektionen

Cappuccino opaco - Frontali Vetro Bronzo - Lavabo Soffio Bronzo satinato -  
Specchiera Omega - Scaffale Tube Cappuccino

/ Cappuccino matt - Glass fronts, Bronzo -  
Washbasin Soffio, Bronzo Satin - Mirror Omega -  
Shelf Tube, Cappuccino

/ Cappuccino mat - Façades en verre, Bronze  
Lavabo Soffio, Bronze satiné - Miroir Omega -  
Étagère Tube Cappuccino

/ Cappuccino matt - Fronten aus Bronzeglas  
Satinieretes Waschbecken Soffio, Bronze - Spiegel  
Omega - Regal Tube Cappuccino





Personalizza e rendi unico il tuo bagno con i frontali in vetro Bronzo.  
Le mensole orizzontali, coordinate all'apertura a gola, definiscono i nuovi elementi a giorno integrati alla composizione.



/ Personalize and make your bathroom unique with bronzed glass fronts.  
Horizontal shelves, coordinated with the groove opening, define the new open elements of this composition.

/ Personnalisez et rendez votre salle de bains unique avec les façades en verre Bronze.  
Les étagères horizontales, coordonnées avec l'ouverture à gorge, définissent les nouveaux éléments ouverts de la composition.

/ Gestalten Sie Ihr Bad individuell und einzigartig mit den Fronten aus Glas.  
Horizontale Ablage, die mit der Griffmulde koordiniert sind, definieren die neuen, in die Komposition integrierten offenen Elemente.



# #05 C'è una composizione per ogni spazio!

Cappuccino opaco - Frontali Vetro Bronzo - Lavabo Soffio Bronzo satinato - Specchiera Omega - Scaffale Tube Cappuccino

## #05

Comp. YO 05  
L. 195 x P. 50 x H. 50 cm



## #05A

Comp. YO 05A  
L. 170 x P. 50 x H. 50 cm



/ There is a composition for every space!

/ Cappuccino matt - Glass fronts, Bronzo - Washbasin Soffio, Bronzo Satin - Mirror Omega - Shelf Tube, Cappuccino

/ Il y a une composition pour chaque espace!

/ Cappuccino mat - Façades en verre, Bronze - Lavabo Soffio, Bronze satiné - Miroir Omega - Étagère Tube Cappuccino

/ Wir haben eine Komposition für jeden Raum!

/ Cappuccino matt - Fronten aus Bronzeglas - Satiniertes Waschbecken Soffio, Bronze - Spiegel Omega - Regal Tube Cappuccino

## #05B

Comp. YO 05B  
L. 170 x P. 50 x H. 50 cm



## #05C

Comp. YO 05C  
L. 120 x P. 50 x H. 50 cm





# #06

Comp. YO 06 L. 240 x P. 50 x H. 37,5 cm

/ Ricercatezza  
materica.

/ Materic refinement.  
/ Raffinement matérielle.  
/ Materische Veredelung.

Lino opaco - Pensili Tortora opaco - Frontali Gres Diamond Cream -  
Lavabo Soffio Bronzo satinato - Specchiera Area

/ Lino matt - Wall cabinets, Tortora matt - Porcelain  
Stoneware Fronts, Diamond Cream - Washbasin  
Soffio, Bronzo satin - Mirror Area

/ Lino mat - Meubles hauts Tortora mat - Façades en  
grès Diamond Cream - Vasque Soffio, Bronze satiné -  
Miroir Area

/ Lino matt - Hängeschränke Tortora matt - Fronten  
aus Feinsteinzeug Diamond Cream - Satiniertes  
Waschbecken Soffio, Bronze - Spiegel Area





Pensile con apertura a ribalta e luce led da posizionare sottopensile.  
 Box doccia mod. Way Creta opaco di Agha.  
 - Piatto mod. Step S Creta di Agha.



/ Wall unit with bottom-hung door and led light placed under the wall unit.  
 Shower enclosure mod. Way by Agha, Creta matt.  
 - Shower tray mod. Step S by Agha, Creta.

/ Meuble haut avec porte abattante et éclairage LED positionnée au-dessous.  
 Paroi de douche mod. Way by Agha, Creta matt.  
 - Receveur Step S by Agha, Creta.

/ Hängeschränk mit Klappöffnung und unten positionierte LED-Beleuchtung.  
 Duschabtrennung mod. Way Creta matt by Agha.  
 Duschwanne mod. Step S Creta by Agha.



Lavabo mod. Soffio Bronzo satinato

/ Washbasin mod. Soffio, Bronzo satin

/ Lavabo mod. Soffio, Bronze satiné

/ Satiniertes Waschbecken Soffio, Bronze

# #06 C'è una composizione per ogni spazio!

Lino opaco - Pensili Tortora opaco - Frontali Gres Diamond Cream - Lavabo Soffio Bronzo satinato - Specchiera Area

## #06

Comp. YO 06  
L. 240 x P. 50 x H. 37,5 cm



## #06A

Comp. YO 06A  
L. 215 x P. 50 x H. 37,5 cm



/ There is a composition for every space!

/ Lino matt - Wall cabinets, Tortora matt - Porcelain Stoneware Fronts, Diamond Cream - Washbasin Soffio, Bronzo satin - Mirror Area

/ Il y a une composition pour chaque espace!

/ Lino mat - Meubles hauts Tortora mat - Façades en grès Diamond Cream - Vasque Soffio, Bronze satiné - Miroir Area

/ Wir haben eine Komposition für jeden Raum!

/ Lino matt - Hängeschränke Tortora matt - Fronten aus Feinsteinzeug Diamond Cream - Satiniertes Waschbecken Soffio, Bronze - Spiegel Area

## #06B

Comp. YO 06B  
L. 190 x P. 50 x H. 37,5 cm



## #06C

Comp. YO 06C  
L. 95 x P. 50 x H. 37,5 cm



# #07

Comp. YO 07 L. 295 x P. 50 x H. 50 cm

/ Espressione  
d'eleganza.

/ Expression of elegance.  
/ Expression de l'élégance.  
/ Ausdruck von Eleganz.

Geowood Moka - Nickel - Frontali Geowood Moka -  
Lavabo City Ceramica Bianco opaco - Specchiere Illusion

/ Geowood Moka - Nickel - Geowood Moka fronts -  
Washbasin City, matt white ceramic -  
Mirrors Illusion

/ Geowood Moka - Nickel - Façades Geowood Moka -  
Vasque en céramique City, blanc mat -  
Miroirs Illusion

/ Geowood Moka - Nickel - Geowood Moka Fronten -  
Waschbecken City aus Keramik, Weiß matt -  
Spiegel Illusion





Nuove riflessioni con le geometrie delle specchiere Illusion.  
Pensile mod. Tube in metallo laccato Nero opaco.



/ New reflections with the geometries  
of mirrors Illusion.  
Wall unit mod. Tube in matt black lacquered metal.

/ Nouveaux reflets avec les géométries  
des miroirs Illusion.  
Élément mural Tube en métal laqué noir mat.

/ Neue Reflexionen mit den Geometrien  
von Spiegel mod. Illusion.  
Hängeschrank mod. Tube aus mattschwarz  
lackiertem Metall.



# #07 C'è una composizione per ogni spazio!

Geowood Moka - Nichel - Frontali Geowood Moka -  
Lavabo City Ceramica Bianco opaco - Specchiere Illusion



#07

Comp. YO 07  
L. 295 x P. 50 x H. 50 cm



#07A

Comp. YO 07A  
L. 220 x P. 50 x H. 50 cm

/ There is a composition for every space!

/ Geowood Moka - Nichel - Geowood Moka fronts -  
Washbasin City, matt white ceramic -  
Mirrors Illusion

/ Il y a une composition pour chaque espace!

/ Geowood Moka - Nichel - Façades Geowood Moka -  
Vasque en céramique City, blanc mat -  
Miroirs Illusion

/ Wir haben eine Komposition für jeden Raum!

/ Geowood Moka - Nichel - Geowood Moka Fronten -  
Waschbecken City aus Keramik, Weiß matt -  
Spiegel Illusion



#07B

Comp. YO 07B  
L. 165 x P. 50 x H. 50 cm



#07C

Comp. YO 07C  
L. 85 x P. 50 x H. 50 cm



# #08

Comp. YO 08 L. 210 x P. 50 x H. 25 cm

/ Fascino contemporaneo.

/ Contemporary charm.  
/ Charme contemporain.  
/ Zeitgenössischer Charme.

Blu Notte opaco - Frontali Blu Notte opaco -  
Lavabo Mistral Blu Notte - Specchiera Illusion

/ Blu Notte matt - Fronts Blu Notte matt - Top with  
integrated basin Mistral, Blu Notte - Mirror Illusion

/ Blu Notte mat - Façades laquées, Blu Notte mat -  
Plan vasque Mistral Blu Notte - Miroir Illusion

/ Blu Notte matt - Fronten aus Blu Notte matt -  
Waschtisch Mistral Blu Notte - Spiegel Illusion



I nuovi elementi a giorno Ardeco permettono di creare soluzioni d'arredo e contenimento che completano perfettamente il tuo bagno.



/ Ardeco's new open elements allow you to create furniture and storage solutions that perfectly complete your bathroom.

/ Les nouveaux éléments ouverts de Ardeco vous permettent de créer des meubles et des solutions de rangement qui s'intègrent parfaitement à votre salle de bains.

/ Mit den neuen offenen Elementen von Ardeco können Sie Möbel und Enthalten-Lösungen schaffen, die Ihr Bad perfekt ergänzen.





Lavabo Mistral in Mineral Tech, frontali e struttura Blu notte opaco: ogni elemento Ardeco coordinato in perfetta armonia.

/ Mineraltech vanity top Mistral with integrated basin, Blu notte matt fronts and structure: every element coordinated in a perfect harmony.

/ Plan vasque Mistral en Mineral Tech, façades et structure Blu Noite mat: chaque élément Ardeco est coordonné en parfaite harmonie.

/ Waschbecken Mistral aus Mineral Tech, Blu notte matt lackierte Fronten und Korpus: jedes Element ist auf das andere in perfekter Harmonie abgestimmt.

# #08 C'è una composizione per ogni spazio!

Blu Notte opaco - Frontali Blu Notte opaco -  
Lavabo Mistral Blu Notte - Specchiera Illusion

## #08

Comp. YO 08  
L. 210 x P. 50 x H. 25 cm

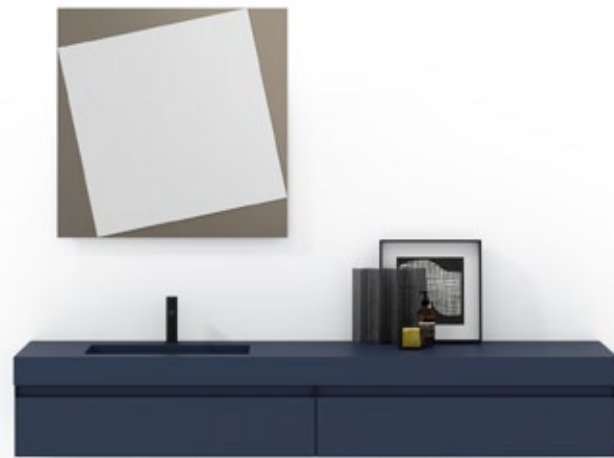

## #08A

Comp. YO 08A  
L. 190 x P. 50 x H. 25 cm



/ There is a composition for every space!

/ Blu Notte matt - Fronts Blu Notte matt - Top with  
integrated basin Mistral, Blu Notte - Mirror Illusion

/ Il y a une composition pour chaque espace!

/ Blu Notte mat - Façades laquées, Blu Notte mat -  
Plan vasque Mistral Blu Notte - Miroir Illusion

/ Wir haben eine Komposition für jeden Raum!

/ Blu Notte matt - Fronten aus Blu Notte matt -  
Waschtisch Mistral Blu Notte - Spiegel Illusion

## #08B

Comp. YO 08B  
L. 145 x P. 50 x H. 25 cm



## #08C

Comp. YO 08C  
L. 120 x P. 50 x H. 25 cm



# #09

Comp. YO 09 L. 225 x P. 50 x H. 50 cm

/ Armonia cromatica.

/ Chromatic harmony.  
/ Harmonie des couleurs.  
/ Chromatische Harmonie.

Roccia opaco - Frontali Muschio opaco -  
Lavabo Mistral Roccia - Specchiera Illusion

/ Roccia matt - Fronts Muschio matt - Top with integrated basin Mistral Roccia - Mirror Illusion

/ Roccia mat - Façades Muschio mat - Plan vasque Mistral , Roccia - Miroir Illusion

/ Roccia matt - Fronten aus Muschio matt - Waschtisch Mistral Roccia - Spiegel Illusion





Lavabo mod. Mistral in Mineral Tech Roccia opaco.  
 Box doccia mod. Fashion Roccia opaco di Agha.  
 - Piatto mod. Step Creta di Agha.



/ Top with integrated basin mod. Mistral, Mineral Tech Roccia matt.  
 Shower enclosure mod. Fashion by Agha, Roccia matt.  
 Shower tray mod. Step by Agha Creta.

/ Lavabo mod. Mistral en Mineral Tech, Roccia mat.  
 Paroi de douche Fashion by Agha, Roccia mat.  
 Receveur Step by Agha, Creta.

/ Waschtisch mod. Mistral in Mineral Tech, Roccia matt.  
 Duschabtrennung mod. Fashion by Agha, Roccia matt lackierte.  
 Duschwanne mod. Step by Agha, Creta.

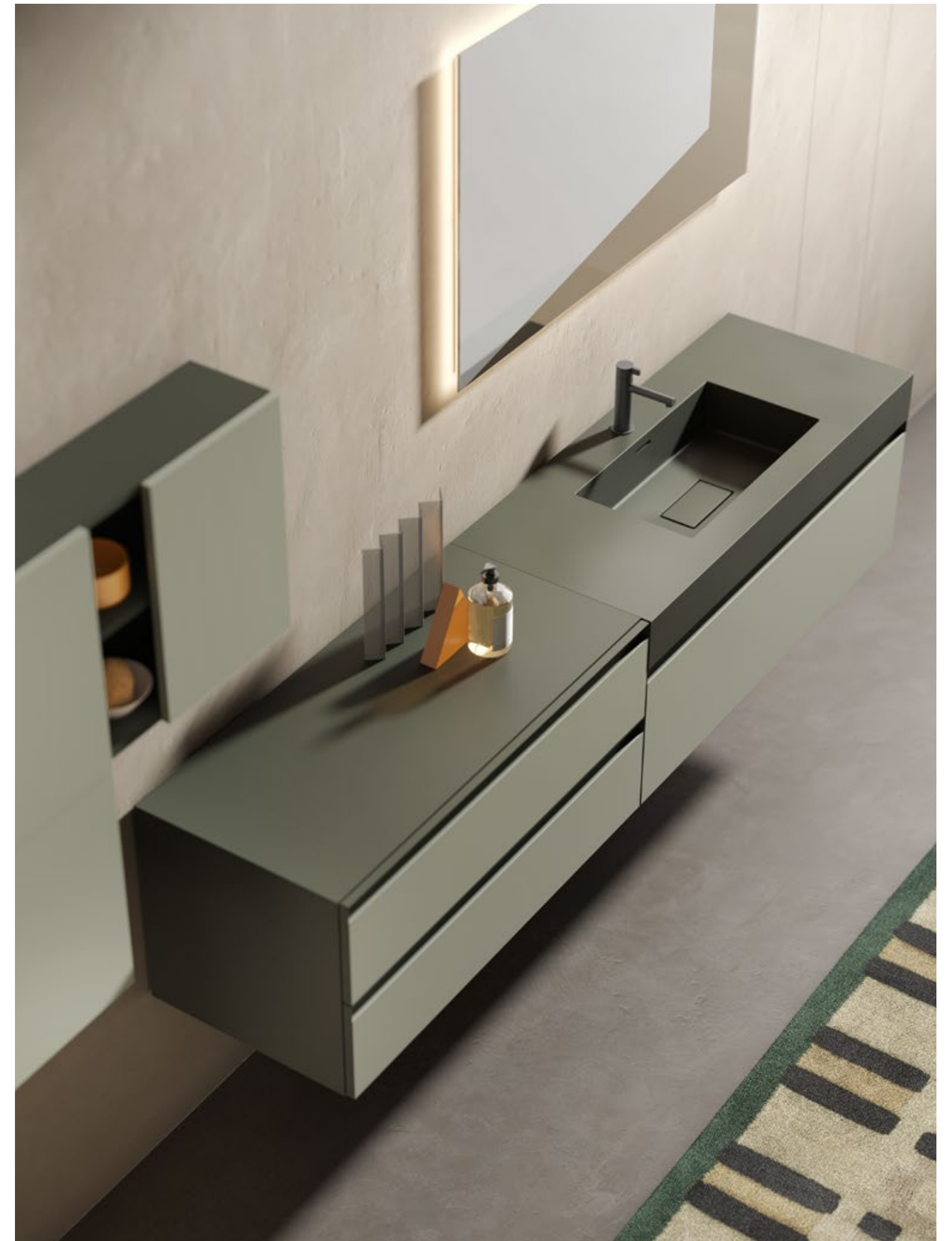

# #09 C'è una composizione per ogni spazio!

Roccia opaco - Frontali Muschio opaco -  
Lavabo Mistral Roccia - Specchiera Illusion

## #09

Comp. YO 09  
L. 225 x P. 50 x H. 50 cm



## #09A

Comp. YO 09A  
L. 205 x P. 50 x H. 50 cm



/ There is a composition for every space!

/ Roccia matt - Fronts Muschio matt - Top with integrated basin Mistral Roccia - Mirror Illusion

/ Il y a une composition pour chaque espace!

/ Roccia mat - Façades Muschio mat - Plan vasque Mistral, Roccia - Miroir Illusion

/ Wir haben eine Komposition für jeden Raum!

/ Roccia matt - Fronten aus Muschio matt - Waschtisch Mistral Roccia - Spiegel Illusion

## #09B

Comp. YO 09B  
L. 180 x P. 50 x H. 50 cm



## #09C

Comp. YO 09C  
L. 140 x P. 50 x H. 50 cm





# #10

Comp. YO 10 L. 190 x P. 46 x H. 62,5 cm

/ Raffinato  
calore.

/ Refined warmth.  
/ Chaleur raffinée.  
/ Raffinierte Wärme.

Conchiglia opaco - Nero Opaco - Frontali Conchiglia opaco -  
Top vetro acidato Conchiglia - Specchiere Omega

/ Conchiglia matt - Nero Matt - Fronts Conchiglia  
matt - Etched extra-light glass top, Conchiglia -  
Mirrors Omega

/ Conchiglia mat - Noir mat - Façades Conchiglia  
mat - Plan en verre extra-clair satiné avec vasque  
moulée, Conchiglia - Miroirs Omega

/ Conchiglia matt - Nero Matt - Conchiglia matt  
Fronten - Satinierter extraheller Glaswaschtisch,  
Conchiglia - Spiegel Omega





Crea volumi sospesi e leggeri con l'illuminazione led nella parte inferiore della composizione.  
Top in vetro extralight acidato Conchiglia.



/ Create suspended and light volumes with the Led light in the lower part of the composition.  
Etched extra-light glass top, Conchiglia.

/ Créez des volumes suspendus et légers grâce à l'éclairage Led placé au-dessous des meubles bas.  
Plan en verre extra-clair satiné avec vasque moulée, Conchiglia.

/ Sie können leichte, schwebende Volumen mit der Led-Beleuchtung unten den Unterschränken schaffen. Satinierter extraheller Glaswaschtisch, Farbe Conchiglia.

# #10 C'è una composizione per ogni spazio!

Conchiglia opaco - Nero Opaco - Frontali Conchiglia opaco - Top vetro acidato Conchiglia - Specchiere Omega

## #10

Comp. YO 10  
L. 190 x P. 46 x H. 62,5 cm



## #10A

Comp. YO 10A  
L. 170 x P. 46 x H. 62,5 cm



/ There is a composition for every space!

/ Conchiglia matt - Nero Matt - Fronts Conchiglia matt - Etched extra-light glass top, Conchiglia - Mirrors Omega

/ Il y a une composition pour chaque espace!

/ Conchiglia mat - Noir mat - Façades Conchiglia mat - Plan en verre extra-clair satiné avec vasque moulée, Conchiglia - Miroirs Omega

/ Wir haben eine Komposition für jeden Raum!

/ Conchiglia matt - Nero Matt - Conchiglia matt Fronten - Satinierter extraheller Glaswaschtisch, Conchiglia - Spiegel Omega

## #10B

Comp. YO 10B  
L. 105 x P. 46 x H. 62,5 cm



## #10C

Comp. YO 10C  
L. 120 x P. 46 x H. 62,5 cm



# Composizioni

/ Compositions - Compositions  
Zusammenstellungen

Scegli la composizione perfetta per il tuo bagno e le tue esigenze.

/ Choose the perfect composition for your bathroom and your needs.

/ Choisissez la composition idéale pour votre salle de bains et vos besoins.

/ Wählen Sie die perfekte Zusammenstellung für Ihr Badezimmer und Ihre Bedürfnisse.



**Composition#5**  
YO 05 L. 195 x P. 50 x H. 50 cm

pg.40

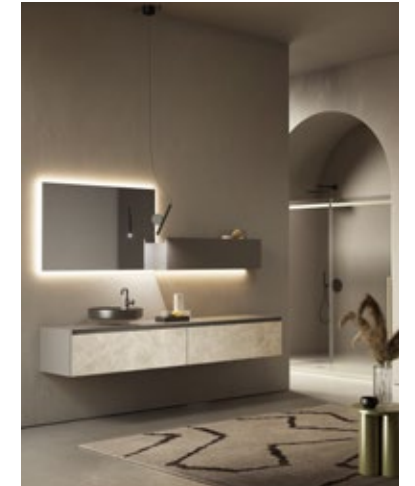

**Composition#6**  
YO 06 L. 240 x P. 50 x H. 37,5 cm

pg.46



**Composition#1**  
YO 01 L. 240 x P. 50 x H. 50 cm

pg.06

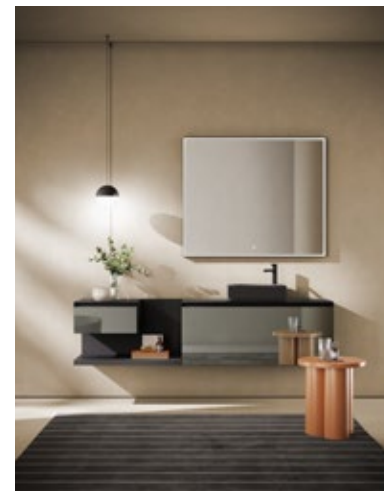

**Composition#2**  
YO 02 L. 205 x P. 50 x H. 50 cm

pg.14

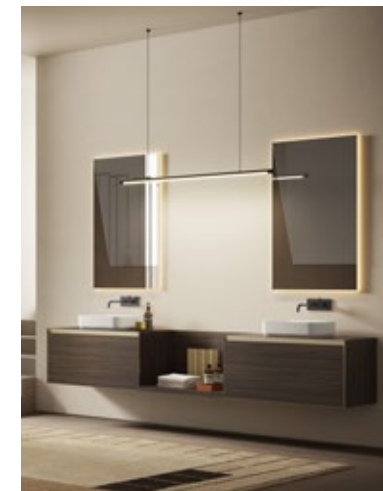

**Composition#7**  
YO 07 L. 295 x P. 50 x H. 50 cm

pg.52



**Composition#8**  
YO 08 L. 210 x P. 50 x H. 25 cm

pg.58



**Composition#3**  
YO 03 L. 220 x P. 50 x H. 25 cm

pg.22



**Composition#4**  
YO 04 L. 240 x P. 50 x H. 37,5 cm

pg.28



**Composition#9**  
YO 09 L. 225 x P. 50 x H. 50 cm

pg.70

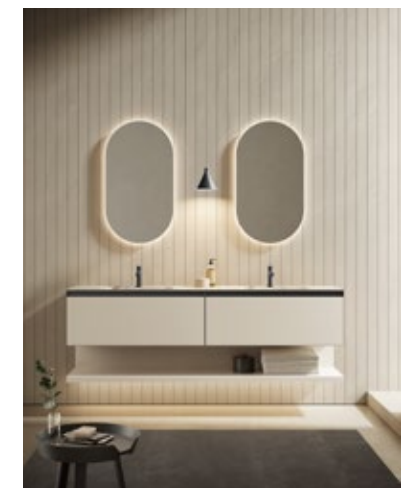

**Composition#10**  
YO 10 L. 190 x P. 46 x H. 62,5 cm

pg.82

## Caratteristiche

/ Characteristics - Caractéristiques  
Merkmale

## YOKO Collection

/ Essenzialità materica.

/ Materic essentiality.  
/ Essentialité matériq.ue.  
/ Materische Wesentlichkeit.

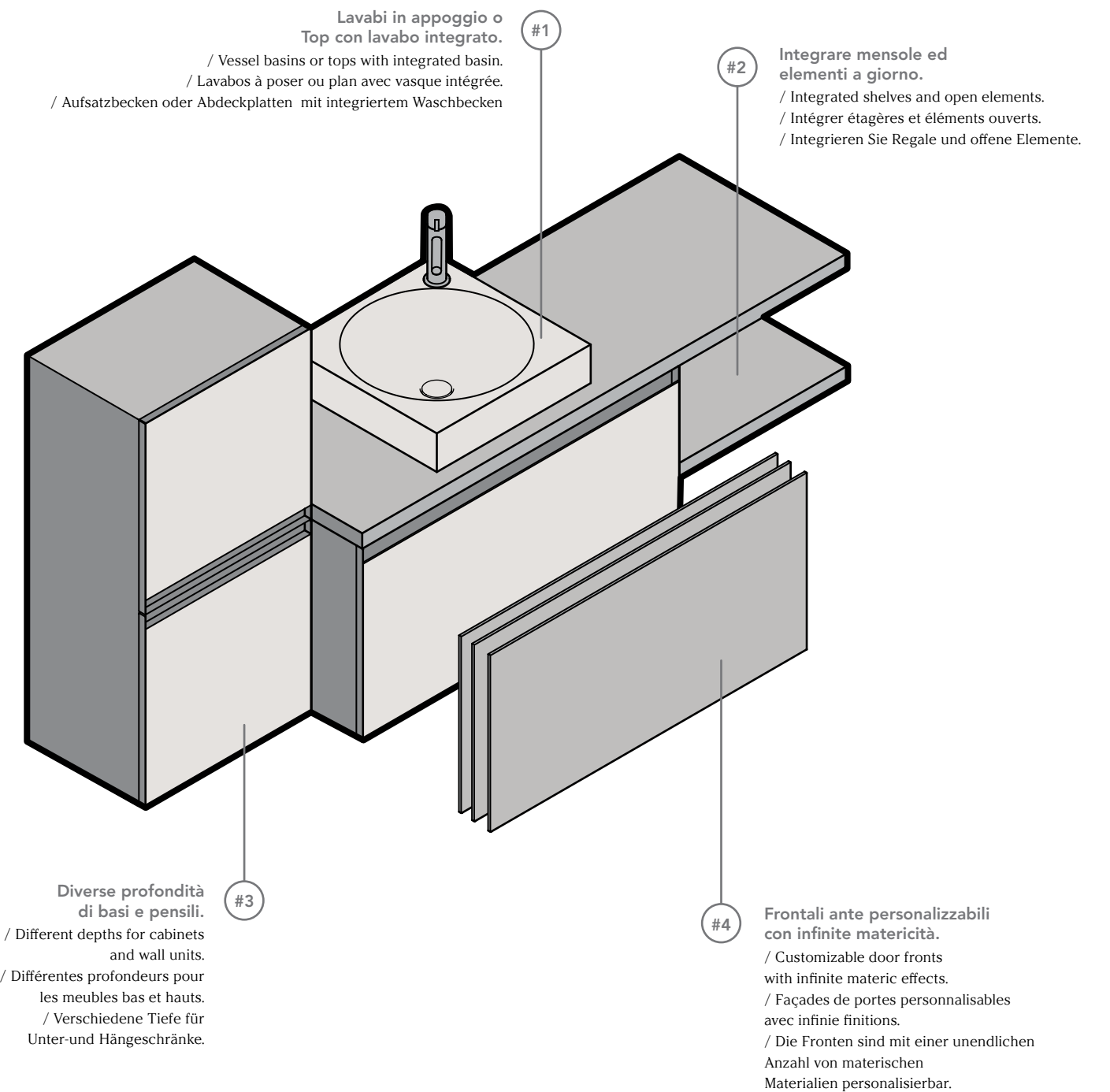

# Dettagli di qualità

/ Quality details - Détails de qualité - Hochwertige Details



Ante in metallo laccato con gola integrata.

/ Doors with metal frame and lacquered fronts with integrated groove.

/ Portes avec cadre en métal et façades laquées avec gorge intégrée.

/ Tür mit Metallrahmen und lackierten Fronten mit Griffmulde.



Struttura e basi realizzate in folding.

/ Miter-folded structure for the cabinets.

/ Structure des meubles avec «angles pliés à 90°».

/ Korpus der Unterschränke mit Eckverbindung auf Gehrung.

# Tutto a portata di mano

/ Everything at your fingertips - Tout à portée de main - Alles auf Knopfdruck.



Cassetti interni carenati in metallo finitura Bianco o Nero opaco.

/ Drawer structures in metal,  
White or Matt Black finish.

/ Tiroirs en métal avec une finition  
blanche ou noire mate.

/ Innenschubladen aus Metall,  
in Weiß oder Schwarz.



Accessori per cassetti Ardeco:  
Illuminazione interna cassetti / Divisori in vetro / Portaoggetti laccati

/ Ardeco's accessories for drawers:  
Inner drawer lighting / Glass organizers /  
Lacquered object-holders

/ Accessoires pour tiroirs Ardeco  
Eclairage intérieur des tiroirs / Séparateurs  
en verre / Porte-objets laqués

/ Ardeco Zubehör für Schubladen  
Innenbeleuchtung für Schubladen /  
Glasabtrennungen / Lackierte Objektträger

# Certificazioni

/ Certifications - Certifications  
Zertifizierungen



MADE IN ITALY

## Sicurezza e durata

Le scocche sono garantite dal marchio Idropan, uno speciale melaminico idrorepellente, resistente all'acqua e all'umidità, che contraddistingue l'anima nascosta dei mobili di qualità. L'azienda inoltre ha aderito al consorzio del pannello ecologico e utilizza cioè solamente pannelli realizzati con materiale riciclato al 100%. Tutti gli elementi sono studiati per vivere il bagno in tutta sicurezza ogni giorno: cerniere brevettate, agganci e finiture testate contro l'azione dell'umidità, ruote adatte per i contenitori, guide sotto-cassetto a scomparsa, accessori elettrici certificati.

## Safety and durability

The cabinet bodies are guaranteed by Idropan brand, a special water-repellent melamine, resistant to water and moisture, which characterizes furniture of quality. The company has joined also the consortium of the ecological panel and uses only panels made from 100% recycled material. All elements are designed to live in your bathroom safely every day: patented hinges, hooks and finishes tested against moisture, solid wheels, concealed drawer slides, certified electrical accessories.

## Sécurité et durabilité

Les caissons sont garantis par la marque Idropan, une mélamine spéciale hydrofuge, résistante à l'eau et à l'humidité qui caractérise les meubles de qualité. La société a également adhéré au consortium des panneaux écologiques, c'est-à-dire qu'elle n'utilise que des panneaux composés à 100% de matériaux recyclés. Tous les éléments sont conçus pour une utilisation de la salle de bains quotidienne en toute sécurité. Charnières brevetées, quincaillerie et finitions testées contre l'action de l'humidité, roues robustes, coulisses cachées sous les tiroirs, accessoires électriques certifiés.

## Sicherheit und Haltbarkeit

Die Korpuse sind garantiert durch den Markenname Idropan, ein spezielles wasserabweisendes Melamin, wasser- und feuchtigkeitsbeständig, das die Möbel von Qualität auszeichnet. Das Unternehmen hat sich auch dem Konsortium ökologischer Paneele beigetreten, d.h. es verwendet nur Paneele, die zu 100% aus recyceltem Material bestehen. Alle Elemente werden für einen sicheren täglichen Gebrauch konzipiert: patentierte Scharniere, gegen Feuchtigkeitseinwirkung zertifizierte Beschläge und Ausführungen, sichere Räder, verdeckte untere Schubladenföhrungen, zertifiziertes elektrisches Zubehör.



Materiale idrofuogo di qualità resistente all'acqua ed all'umidità.

Quality water repellent material, resistant to water and moisture.

Matériau hydrofuge de qualité résistant à l'eau et à l'humidité.

Hochwertiges wasserabweisendes Material, resistent gegen Wasser und Feuchtigkeit.



Pannello ecologico garantito 100% Legno riciclato.

Guaranteed ecological panel 100% Recycled Wood.

Panneau écologique garanti 100% bois recyclé.

Garantiert ökologisches Paneel, 100% recyceltes Holz.



Marchio europeo di qualità per i componenti elettrici.

European quality label for electrical elements.

Label de qualité européen pour les composants électriques.

Europäisches Qualitätszeichen für elektrische Komponenten.



Artesi ha un proprio Sistema di Gestione della Qualità, certificato dall'ente ICILA, secondo la norma UNI EN ISO 9001:2015. Tale certificazione ha lo scopo di gestire al meglio ogni processo aziendale. Il sistema qualità Artesi, attraverso un'accurata progettazione, selezione e controllo dei fornitori e dei processi produttivi, persegue il principale obiettivo della piena soddisfazione dei propri clienti.

Artesi has its own Management System of Quality, certified by ICILA,

according to the UNI EN ISO 9001:2015 standard. The purpose of this certification is to manage at the best every business process.

Artesi, through a careful planning, selection and control of both suppliers and production processes, pursues the main objective of the full satisfaction of its customers.

Artesi dispose de son propre système de gestion de la qualité certifié par l'ICILA, selon la norme UNI EN ISO 9001:2015.

L'objectif de cette certification est d'optimiser la gestion de chaque processus de l'entreprise. Artesi, grâce à une approfondie conception, sélection et contrôle des fournisseurs et des processus de production, poursuit l'objectif principal de la satisfaction totale du client.

Artesi hat sein eigenes Qualitätsmanagement-System, zertifiziert von ICILA, gemäß der Norm UNI EN ISO 9001:2015.

Der Zweck dieser Zertifizierung ist die Verwaltung Jeden einzelnen Unternehmensprozess. Das Artesi-Qualitätssystem, durch sorgfältige Planung, Auswahl und Kontrolle der Lieferanten und der Produktionsprozessen, verfolgt das Hauptziel der vollen Zufriedenheit seiner Kunden.



## **DESIGNERS**

**YANG COLLECTION** - Enrico Cesana

**Pensile BIRD** / Open cabinet - Sara Modugno



### **AD**

Enrico Cesana

### **GRAPHIC**

Enrico Cesana Studio

### **RENDERING**

Foto d'Artificio

### **STYLING**

Massimiliano Di Domenico

### **FOTOLITO**

LuceGroup

### **STAMPA**

---